



EYE SPLICE 8-STRAND CLASS II

Class II ropes are made in whole or part from any of the following high modulus fibers: Dyneema®, Vectran®, Technora®, and Zylon®.

The eye splice is used to place a permanent loop in the end of a rope, generally for attachment purposes to a fixed point. An eye is also used to form the rope around a thimble, which is used to protect the rope, especially when it is to be attached to a shackle, chain or wire rope.

Additional rope needed for splice:
length of 30 crowns plus length of eye:
with thimble: length of 30 crowns plus
1/2 circ. in feet.

GETTING STARTED

Plaited rope is no more difficult to splice than 3-strand. It is made of 8-strands grouped in 4 pairs. 2 of these pairs turn to the left and 2 to the right. The illustrations show the 2 pairs turning to the left in white and the 2 pairs turning to the right in gray. They will be referred to as the "white" and "gray" pairs. **Note:** The gray pairs are diametrically opposite one another but at a 90-degree angle to the white pairs and vice-versa.

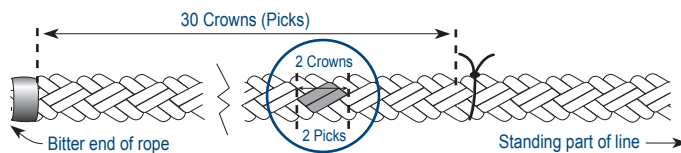

EYE SIZE:

The size of the eye is determined by bending the bitter end of the rope back over itself for a distance equal to the desired length of the eye plus a length of 30 picks (crowns).

PREPARATION:

If the rope which you are about to splice is all of one color, mark those pairs which turn to the right so that they will conform with the gray pairs in the illustrations. Count back a distance of 30 picks from the end and tie a string securely around the rope so it passes directly over the center of both pairs of gray strands. Place the knot so that it is directly on top of one of these pairs. It is important that this be tied securely to prevent slipping. Now, unlay the pairs of strands back to the string. Making sure not to mix, or twist them, tape the ends of the pairs together.

STEP 1

Hold of lay the rope so that the pairs of white strands are on top and bottom with a knot to the right as you look toward the end.

STEP 2

Bend the rope over to form the desired eye in such a way as to keep the knot inside the loop as shown in fig. A.

STEP 3

Using the fid to make clearance and starting with the gray pairs, tuck them under the diametrically opposite white pairs as shown in fig. A. Make sure you do not disturb the lay of the pairs. Do not twist them so that the individual strands cross over one another in the pair.

STEP 4

Now turn eye over, tuck the white pairs under the diametrically opposite gray pairs as shown in fig. B. Note that in fig. B the splice is turned over from fig. A. The white pairs to be tucked should follow the white pairs of the standing part and the gray to be tucked should follow the gray pairs of the standing part. The ends in the drawing have been numbered to help show their position as the tucks progress.

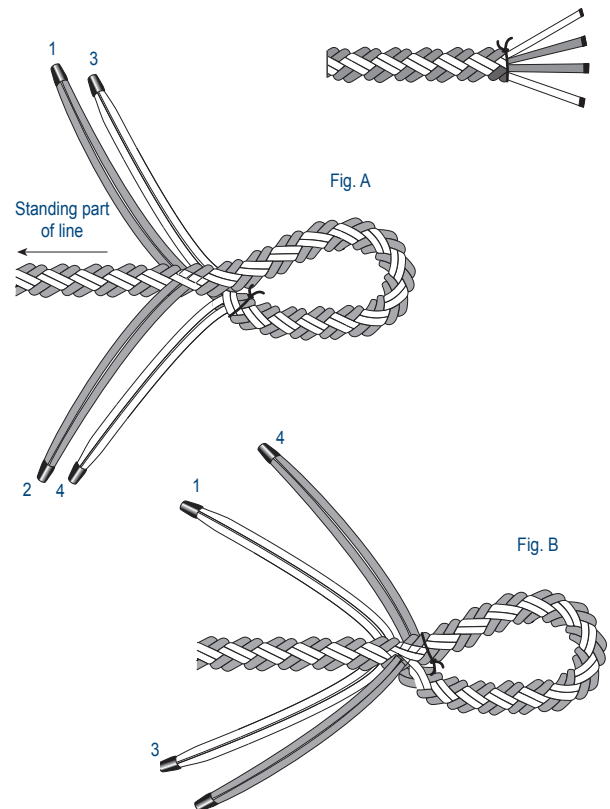



EYE SPLICE 8-STRAND CLASS II

STEP 5

Now you have your eye with the first full tuck complete (a full tuck means inserting all 4 pairs); pull all 4 ends down firmly. Starting with the gray pairs, take another full tuck. By starting with the gray pairs you avoid having to go under 2 pairs at once. Your splice should now look like fig. C, (which now lays on the same side as fig. A). From here on, you should have no difficulty completing the splice.

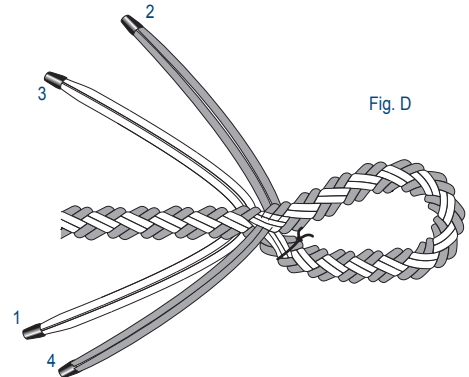
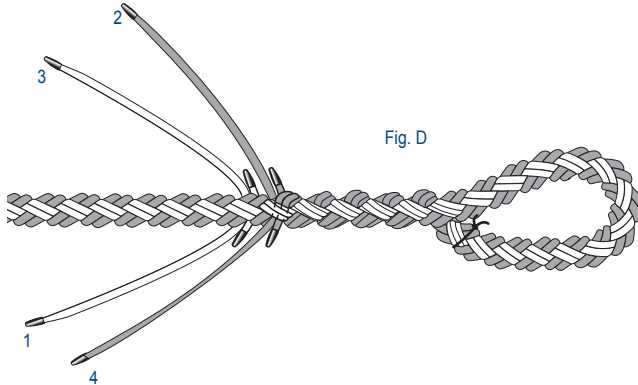

STEP 6

Now starting with the gray pairs, make four more full tucks with each pair of strands.

STEP 7

Having completed 6 full tucks for each pair of strands, select the strand in each pair that is closest to the eye and tape it where it emerges from the tuck. Then cut off the taped strands as shown in fig. D.

STEP 8

Now splice the remaining single strands just as before for another three full tucks. The splice should now appear as shown in fig. E, which will lay on the opposite side as shown in fig. D. Each single strand should now have three full tucks.

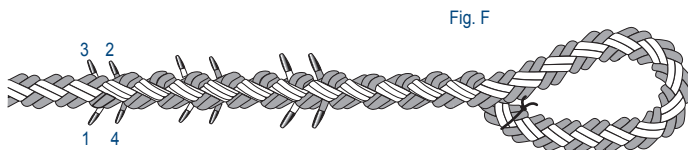
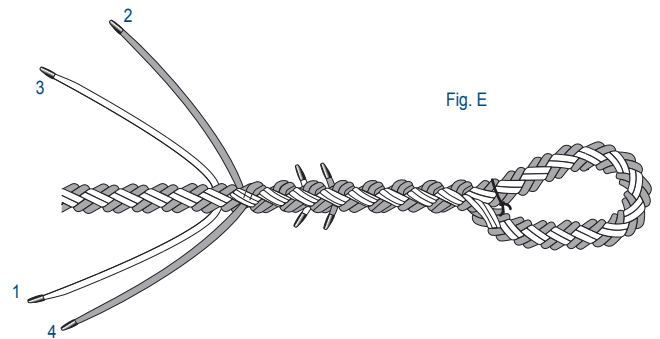

STEP 9

The tapering process continues by reducing the volume of each remaining strand by half (count the number of yarns that comprise each strand and divide as evenly as possible). Select the divided half of each of the four strand yarns.

STEP 10

With the remaining four half-volume single strands, perform three full tucks. Tape the strands after they have been tucked and cut them off as done with previous strands.



END FOR END 8-STRAND CLASS II

Class II ropes are made in whole or part from any of the following high modulus fibers: Dyneema®, Vectran®, Technora®, and Zylon®.

Additional rope needed for splice: length of 30 crowns x 2.

STEP 1 GETTING STARTED

Lay ropes out and count 30 picks or crowns from end of both ropes. Tie string or tape securely at these points

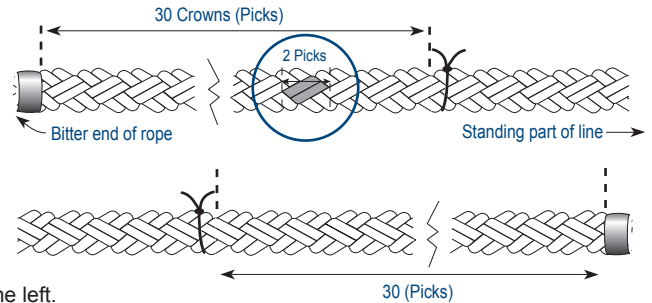

STEP 2 MARKING

Holding the end of the rope, note the pairs of strands going to the left. Mark these pairs. Mark the strands up to the string and continue to mark the strands for five (5) or more picks beyond the strings.

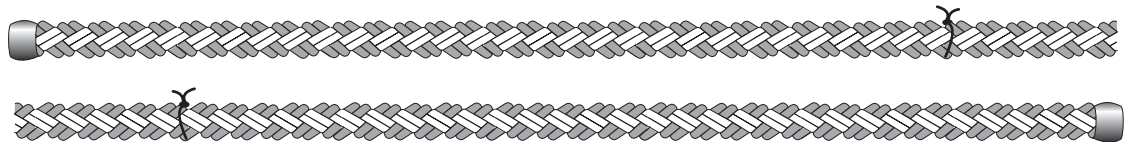

STEP 3 SEPARATING & TAPING

Remove tape from end. Start unlaying strands in their respective pairs. It is important to keep them together. After they are separated into pairs up to the string, untwist the pairs. Tape the ends of pairs together with a taper as shown.

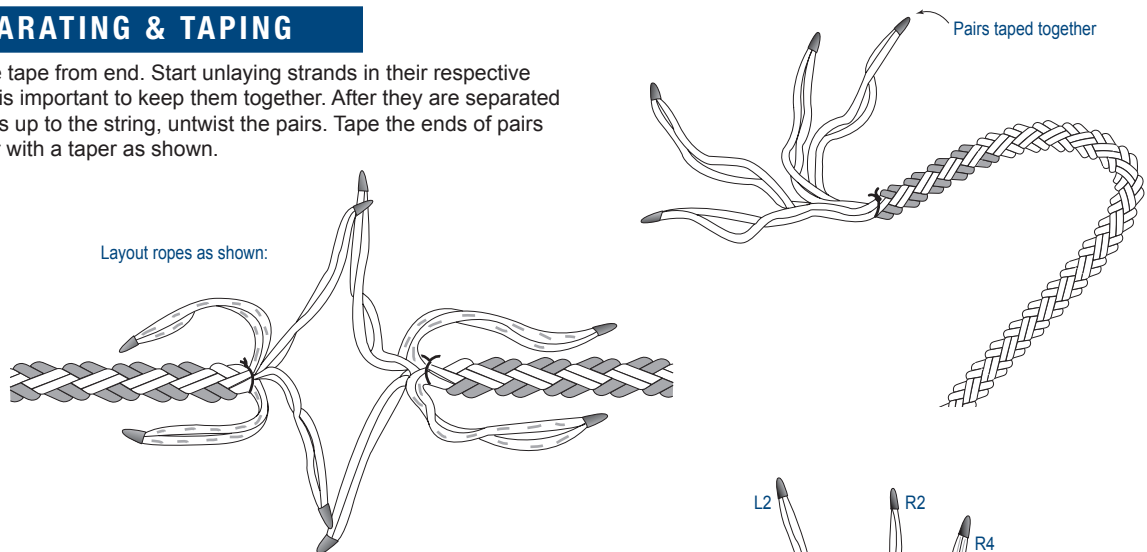

STEP 4 JOINING THE PAIRS

It is important that the next steps of the procedure be followed carefully.

Marked L [1] Strands go between Marked R [1] Strands
 Unmarked R [2] Strands go between Unmarked L [2] Strands
 Unmarked L [3] Strands go between Unmarked R [3] Strands
 Marked R [4] Strands go between Marked L [4] Strands

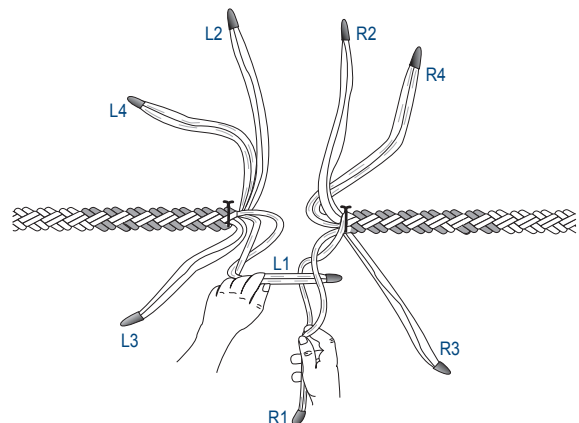



END FOR END 8-STRAND CLASS II

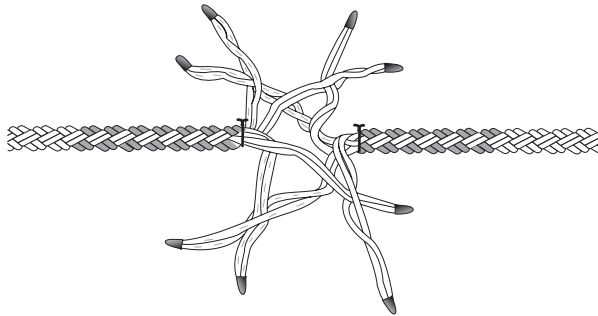

STEP 5

After the initial step has been completed, you should have something that looks like the drawing at left. Marry the ropes as shown in Step 6. This part is preferably a two-person job. Cut the string that you previously tied at the splicing points of both ropes.

STEP 6

MARRY THE ROPES

Keep the ropes together snugly. Tie a piece of string tightly around the splicing point as shown at right.

Start your splice with a marked pair under an unmarked pair of strands. Now you can follow the same procedure as the eyesplice, but we suggest that you complete one (1) full tuck in one direction and then do a full tuck on the other side of the marriage. Pull everything tight before proceeding.

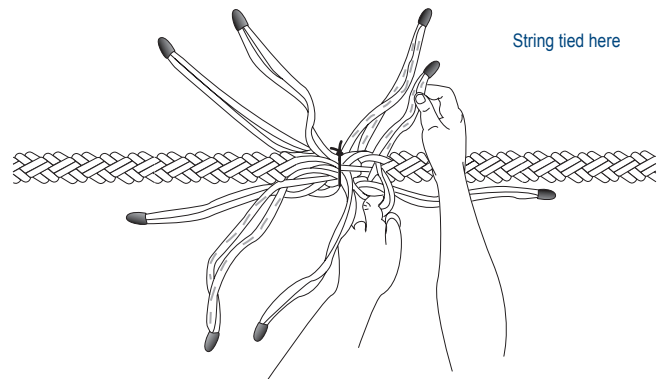

STEP 7

FINISHING THE SPLICE

Complete splicing in both directions so that each side is finished off as per strand reduction sequence (steps 7-10) of the eye splice procedure.

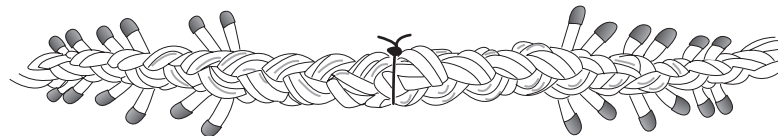



EYE SPLICE 8x3-STRAND CLASS II

Class II ropes are made in whole or part from any of the following high modulus fibers: Dyneema®, Vectran®, Technora®, and Zylon®.

The eye splice is used to place a permanent loop in the end of a rope, generally for attachment purposes to a fixed point. An eye is also used to form the rope around a thimble, which is used to protect the rope, especially when it is to be attached to a shackle, chain or wire rope.

Additional rope needed for splice:
length of 30 crowns plus length eye;
with thimble: length of 30 crowns plus
1/2 circumference in feet.

GETTING STARTED

8x3 rope is no more difficult to splice than 3-strand. It is an 8-strand plaited rope where the strands are made from 3-strand ropes. The 8-strands are grouped into 4 pairs. 2 of these pairs are left-lay and 2 are right-lay. The illustrations show the 2 pairs turning to the left in white and the 2 pairs turning to the right in gray. They will be referred to as the "white" and "gray" pairs. Note: The gray pairs are diametrically opposite one another but at a 90-degree angle to the white pairs and vice-versa.

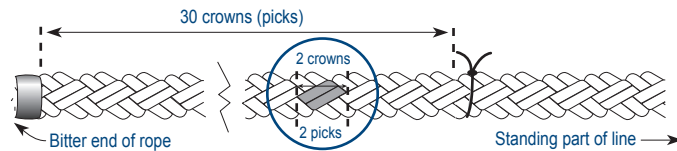

EYE SIZE:

The size of the eye is determined by bending the bitter end of the rope back over itself for a distance equal to the desired length of the eye plus a length of 30 picks (crowns).

PREPARATION:

If the rope which you are about to splice is all of one color, mark those pairs which turn to the right so that they will conform with the gray pairs in the illustrations. Count back a distance of 30 picks from the end and tie a string securely around the rope so it passes directly over the center of both pairs of gray strands. Place the knot so that it is directly on top of one of these pairs. It is important that this be tied securely to prevent slipping. Now, unlay the pairs of strands back to the string. Making sure not to mix, or twist them, tape the ends of the pairs together as shown in Fig. A.

STEP 1 POSITION THE ROPE

Hold or lay the rope so that the pairs of white strands are on top and bottom with a knot to the right as you look toward the end.

STEP 2 Bend the rope over to form the desired eye in such a way as to keep the knot inside the loop as shown in Fig. A.

STEP 3 TUCKING FIRST STRAND

Using the fid to make clearance and starting with the gray pairs, tuck them under the diametrically opposite white pairs as shown in Fig. A. Make sure you do not disturb the lay of the pairs. Do not twist them so that the individual strands cross over one another in the pair.

STEP 4 FINISHING THE FIRST TUCKS

Now turn eye over, tuck the white pairs under the diametrically opposite gray pairs as shown in Fig. B. Note that in Fig. B the splice is turned over from Fig. A. The white pairs to be tucked should follow the white pairs of the standing part and the gray to be tucked should follow the gray pairs of the standing part. The ends in the drawing have been numbered to help show their position as the tucks progress.

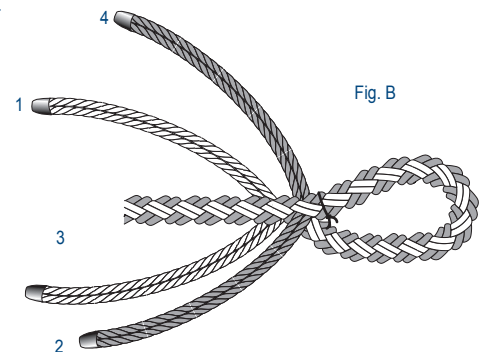
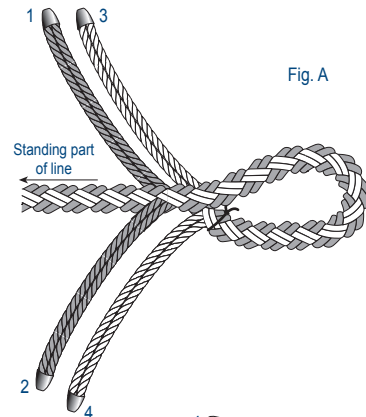



EYE SPLICE 8x3-STRAND CLASS II

STEP 5

CONTINUE TUCKING

Now you have your eye with the first full tuck complete (a full tuck means inserting all 4 pairs); pull all 4 ends down firmly. Starting with the gray pairs, take another full tuck. By starting with the gray pairs you avoid having to go under 2 pairs at once. Your splice should now look like Fig. C, (which now lays on the same side as Fig. A). From here on, you should have no difficulty completing the splice.

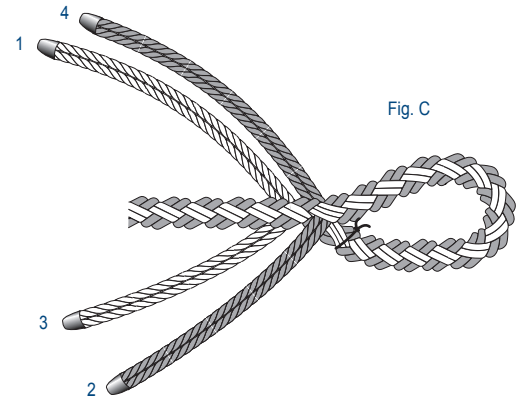

Fig. C

STEP 6

Now starting with the gray pairs, make 4 more full tucks with each pair of strands.

STEP 7

TAPERING THE STRANDS

Having completed 6 full tucks for each pair of strands you will need to reduce the strand volume by 1/3rd before continuing the next set of tucks. To do this, cut one of the three strands out of each strand pair as shown in Fig. D.

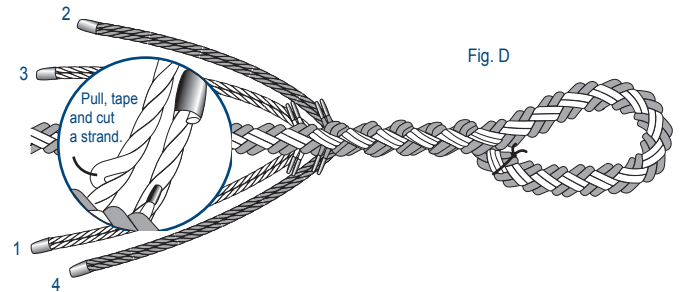

Fig. D

STEP 8

Now splice the remaining strands just as before for another 3 full tucks. The splice should now appear as shown in Fig. E, which will lay on the opposite side as shown in Fig. D. Each strand should now have 3 full tucks.

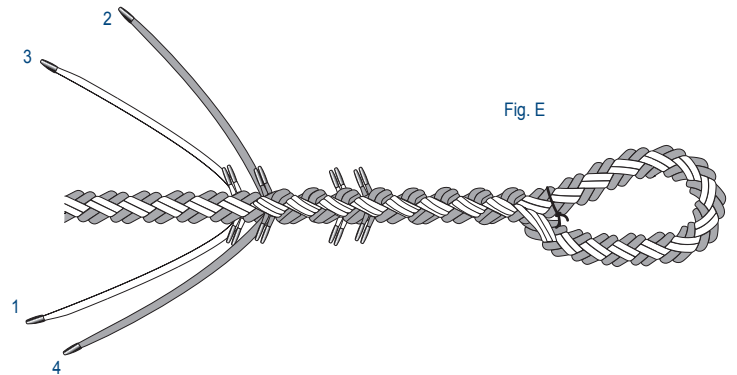

Fig. E

STEP 9

TAPER THE STRANDS

The tapering process continues by reducing the volume of the remaining strands by half (by unlaying both strand-pairs and then removing 1 of the 2 unlayd strands in each strand-pair, as in Step 6).

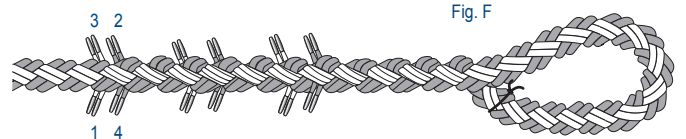

Fig. F

STEP 10

FINISHING THE SPLICE

With the remaining strands, perform 3 full tucks. Tape the strands after they have been tucked and cut them off as done with previous strands.



END FOR END 8x3-STRAND CLASS II

Class II construction ropes are made in whole or part from any of the following high modulus fibers: Dyneema®, Vectran®, Technora®, and Zylon®.

Additional rope needed for splice:
length of 30 crows x 2.

STEP 1

GETTING STARTED

Lay ropes out and count 30 picks or crowns from end of both ropes. Tie string or tape securely at these points

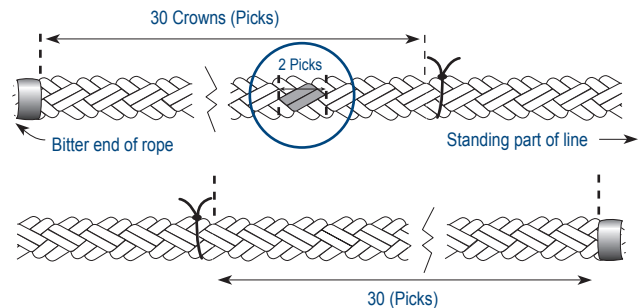

STEP 2

MARKING

Holding the end of the rope, note the pairs of strands going to the left. Mark these pairs. Mark the strands up to the string and continue to mark the strands for five (5) or more picks beyond the strings.

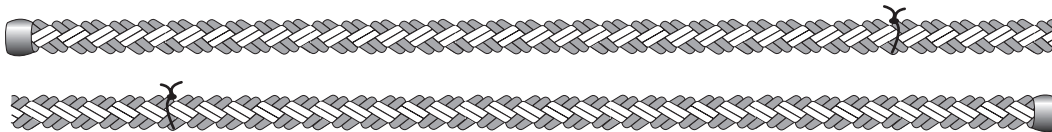

STEP 3

SEPARATING & TAPING

Remove tape from end. Start unlaying strands in their respective pairs. It is important to keep them together. After they are separated into pairs up to the string, untwist the pairs. Tape the ends of pairs together with a taper as shown.

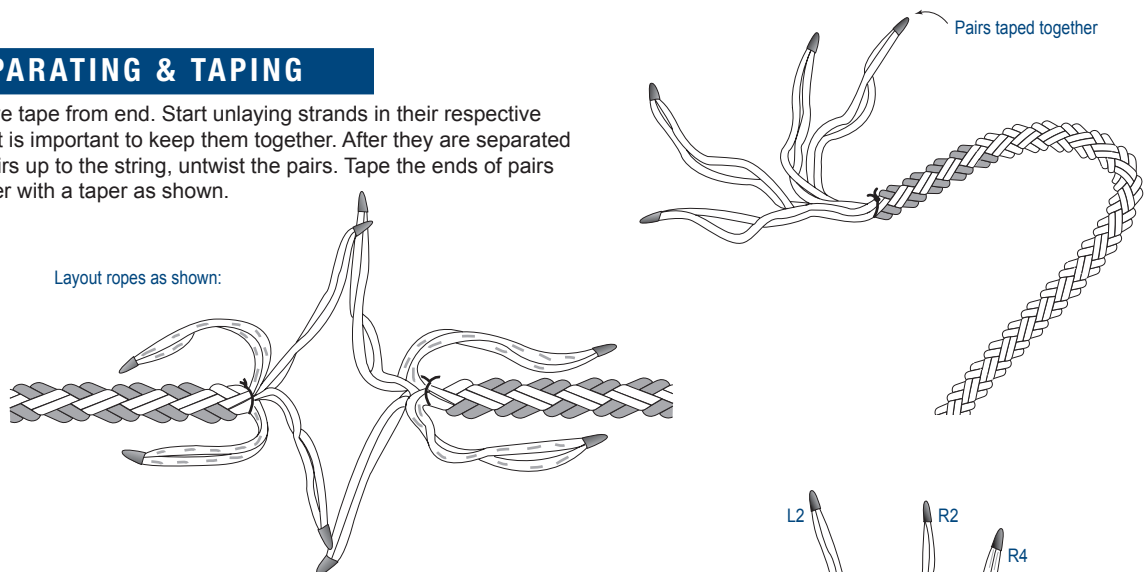

STEP 4

JOINING THE STRANDS

It is important that the next steps of the procedure be followed carefully.

Marked L {1} Strands go between Marked R {1} Strands
Unmarked R {2} Strands go between Unmarked L {2} Strands
Unmarked L {3} Strands go between Unmarked R {3} Strands
Marked R {4} Strands go between Marked L {4} Strands

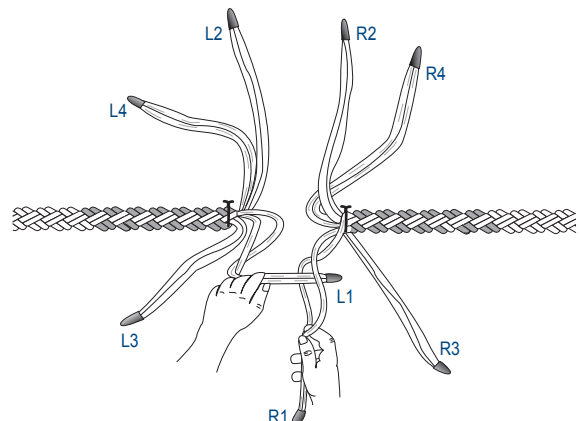



END FOR END 8x3-STRAND CLASS II

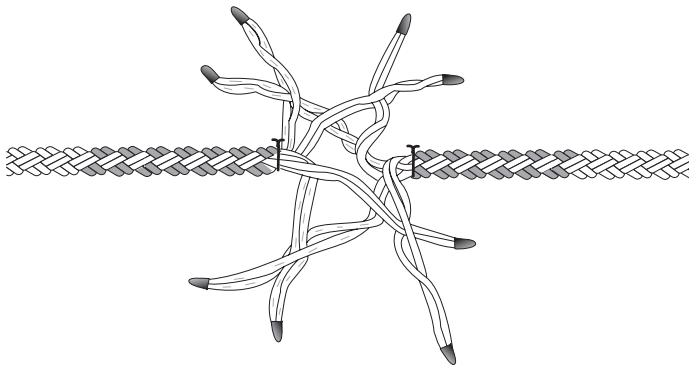

STEP 5

After the initial step has been completed, you should have something that looks like the drawing at left. Marry the ropes as shown in Step 6. This part is preferably a two-person job. Cut the string that you previously tied at the splicing points of both ropes.

STEP 6

MARRYING THE ROPES

Keep the ropes together snugly. Tie a piece of string tightly around the splicing point as shown at right.

Start your splice. A marked pair under an unmarked pair of strands. Now you can follow the same procedure as the eyesplice. But we suggest that you complete one (1) full tuck in one direction and then do a full tuck on the other side of the marriage. Pull everything tight before proceeding.

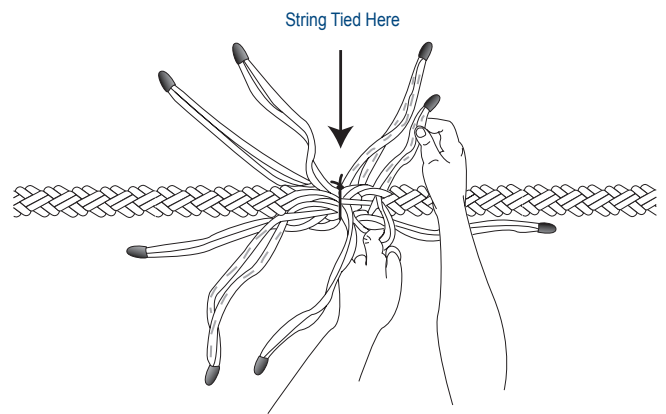

STEP 7

FINISHING THE SPLICE

Complete splicing in both directions so that each side is finished off as per strand reduction sequence (steps 7-10) of the eye splice procedure.

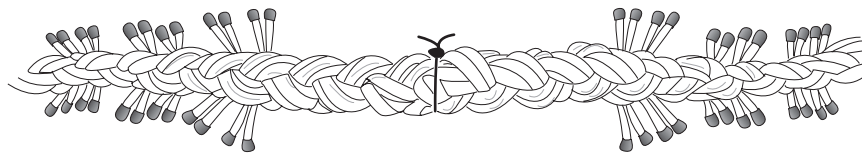



EYE SPLICE 12-STRAND CLASS II

Class II ropes are made in whole or part from any of the following high modulus fibers: Dyneema®, Vectran®, Technora®, and Zylon®.

The eye splice is used to place a permanent loop in the end of a rope, generally for attachment purposes to a fixed point. An eye is also used to form the rope around a thimble, which is used to protect the rope, especially when it is to be attached to a shackle, chain or wire rope.

This eye splice may be performed on new or used rope. This is an all-purpose splice technique designed for people who generally splice used rope as frequently as new rope. By following the procedure below, the splice can retain from 90% to 100% of average new rope strength and in used rope up to the same proportion of residual used rope strength.

Additional rope needed for splice:
3-1/2 fid lengths plus length of eye;
with thimble: 3-1/2 fid lengths plus 1/2
circ. in feet.

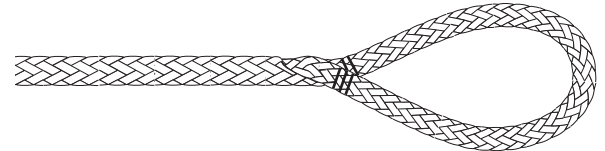

STEP 1 MEASUREMENT

Tape end of line to be spliced and measure 1 tubular fid length (or 2 wire fid lengths because wire fids are half the length of tubular fids) from taped end of line and make Mark 1.

From Mark 1 measure 2 tubular fid lengths (or 4 wire fid lengths) and make Mark 2. Now form size of eye desired and make Mark 3.

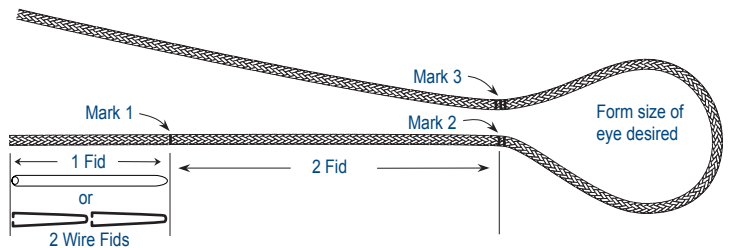

STEP 2 MAKING TAPER

From Mark 1, in the direction of the taped end of the line, mark every second right and left strand* for three strands.** Cut every marked strand and pull out of line (tape at end can cause resistance and may have to be removed in order to pull out cut strands). Tapered end will now have only 6 strands remaining (or 4 strands for an 8 strand braid). Tape tapered tail tightly to keep from unbraiding.

*Some rope diameters may have pairs of strands in right and left direction. In this case, treat the pairs of strands as a single strand, marking and cutting both in each direction as described above.

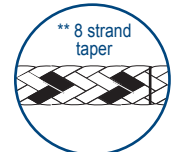
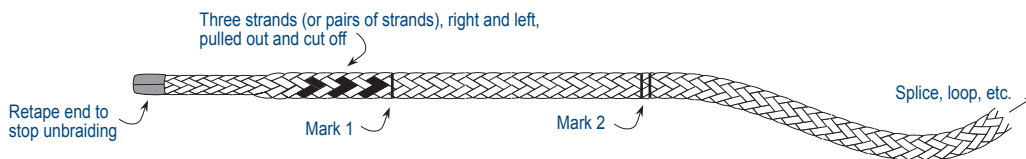

STEP 3 BURY TAIL INTO STANDING PART OF LINE

Measure 3-1/2 tubular fid lengths (7 wire fid lengths), make Mark 4. Insert fid and tapered tail at Mark 3 and bring fid out at Mark 4. Pull fid and tapered tail out. Don't let the line twist.

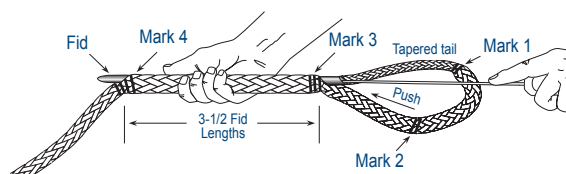



EYE SPLICE 12-STRAND CLASS II

STEP 4

FINISHING BURYING

Remove fid. Pull hard on tapered tail with one hand. With other hand, smooth bunched line towards eye splice until Marks 2 and 3 converge. Now, smooth the cover away from eye towards Mark 4. Mark the tapered tail where it emerges at Mark 4. Pull tail out several inches, cut tail off at an angle, so the angle cut ends at this mark. Then with both hands and weight of body, smooth cover slack to bury tail in standing part of the line.

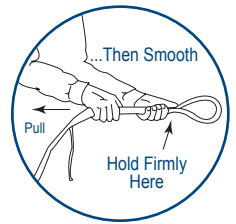
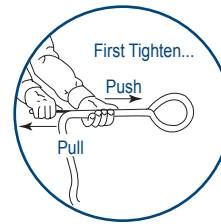
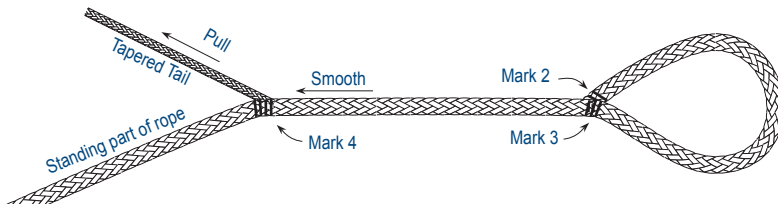

STEP 5

TO FINISH EYE SPLICE

When finished, Mark 2 and Mark 3 should be at the same point in the vertex of the eye—which, yields eye size desired. To finish eye splice, the splice must be lock-stitched (procedure following).

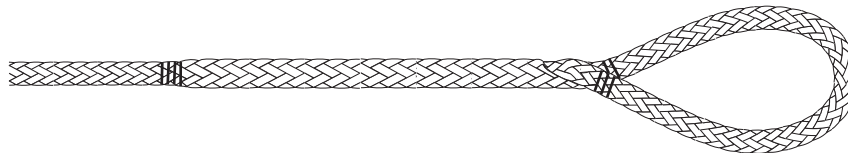

LOCK STITCH PROCEDURE

STEP 1

Pass stitching through spliced area near throat of eye as shown.

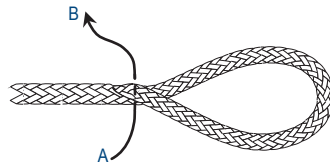

STEP 2

Reinsert as shown pulling snug but not tight.

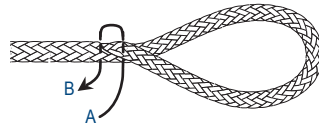

STEP 3

Continue to reinsert as shown until you have at least 3 complete stitches.

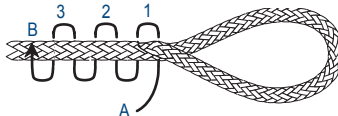

STEP 4

After completing Step 3, rotate spliced part of rope 90° and reinsert end A into spliced area in the same area and in the same fashion as in Steps 1, 2 and 3. The splice will now be stitched on two planes perpendicular to each other.

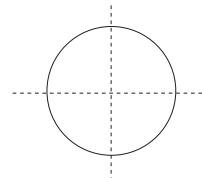

STEP 5

After stitching at least three complete stitches as in Step 3, extract both ends A and B together through the same opening in the braid. Tie them together with a square knot and reinsert back into braid.

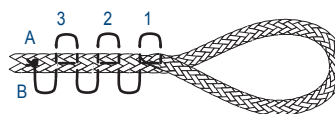



END FOR END 12-STRAND CLASS II

Class II ropes are made in whole or part from high modulus fibers:
Dyneema®, Vectran®, Technora®, and Zylon®.

Additional rope needed for splice:
7 fid lengths.

This end for end splice may be performed on new or used rope. This is an all-purpose splice technique designed for people who generally splice used rope as frequently as new rope. By following the procedure below, the splice can retain from 90% to 100% of average new rope strength and in used rope up to the same proportion of residual used rope strength.



STEP 1 MARKING MEASUREMENTS

Tape ends of line to be spliced. Lay 2 ropes to be spliced side-by-side and measure one tubular fid length, (2 wire fid lengths because wire fids are half size) from taped end of each line and make a mark — Mark 1.

From Mark 1 measure 2 tubular fid lengths (4 wire fid lengths) and make Mark 2 on both lines.

From Mark 2 measure 3-1/2 tubular fid lengths (7 wire fid lengths) and make Mark 3 on both lines.

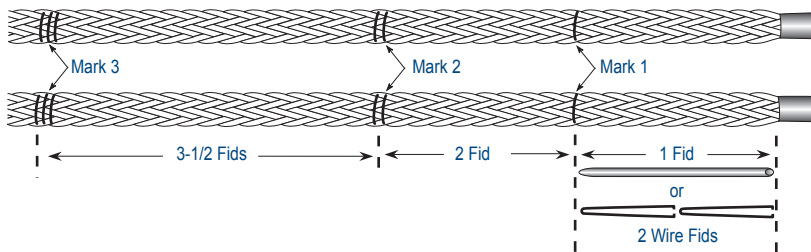

STEP 2 TAPERING TAIL

From Mark 1, in the direction of the taped end of the line, mark every second right and left strand* for 3 strands.**

Cut every marked strand and pull out of line (tape at end can cause resistance and may have to be removed in order to pull out cut strands).

Tapered end will now have only 6 strands remaining (or 4 strands if the rope is an 8-strand construction). Tape tapered tail tightly to keep from unbraiding.

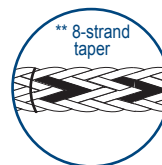
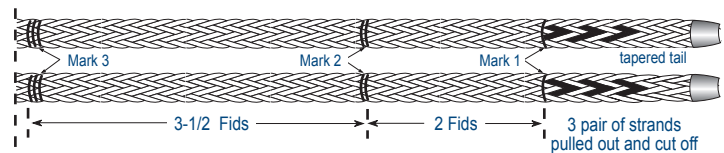

*Some rope diameters may have pairs of strands in right and left direction. In this case, treat the pairs of strands as a single strand, marking and cutting both in each direction as described below.

**For an 8-strand construction, mark every 3rd left and right strand for 2 strands.

STEP 3 REPOSITIONING ROPES

Reposition ropes for splicing according to diagram above.

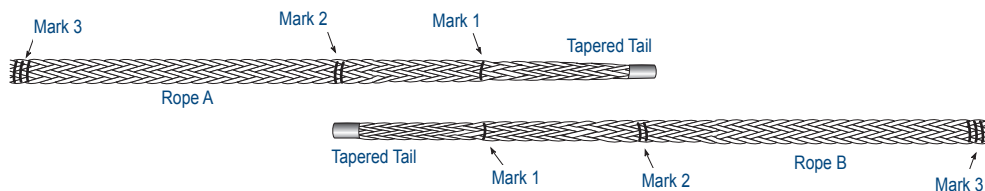



END FOR END 12-STRAND CLASS II

STEP 4

BURYING ROPE A INTO ROPE B

Attach fid to tapered end of Rope A and insert fid into Rope B at Mark 2 and bring out at Mark 3. Then remove fid. Pull tapered tail of Rope A until you have buried up to Mark 2. Once you have fid and tapered tail through the line, tie off tail to stationary object; then use both hands and weight of body to bury Rope B up to Mark 2. Leave tail sticking out.

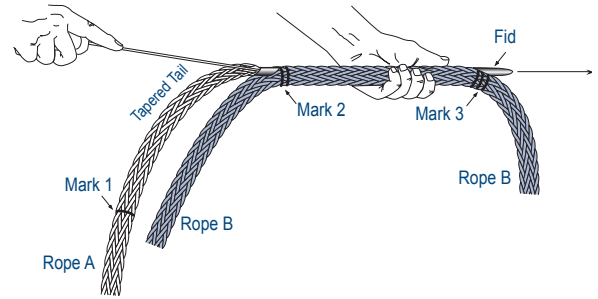

STEP 5

FINISH BURYING

Attach tapered tail of Rope B to fid. Insert fid into Rope A approximately the diameter of the line away from insertion point of Rope A into Rope B. Bring fid and tail out at Mark 3 of Rope A. Following same procedures as in Step 4 to bury Rope B up to its Mark 2. Leave tail sticking out.

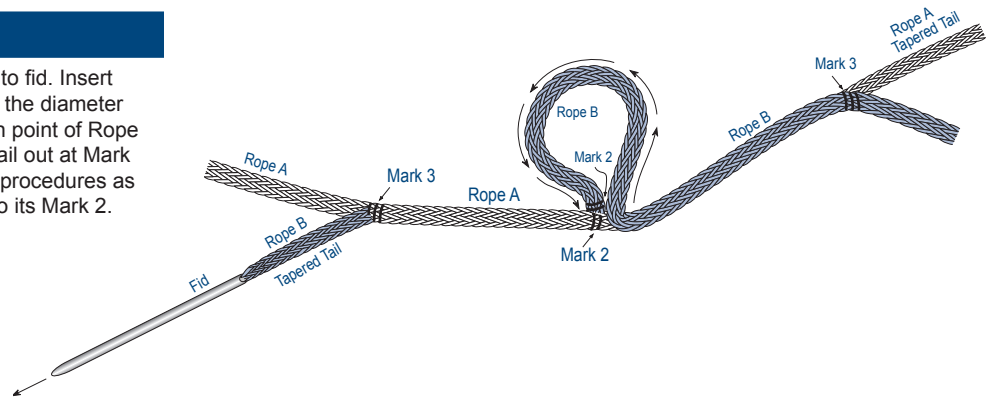

STEP 6

SMOOTH OUT SPLICE

Pull tails to tighten crossover. Then, smooth braid in both directions away from the crossover. Now cut off tails—cut tails on an angle so as to give them a point.

Give a final smoothing, away from crossover, stroking rope firmly. Tails should bury inside cover.

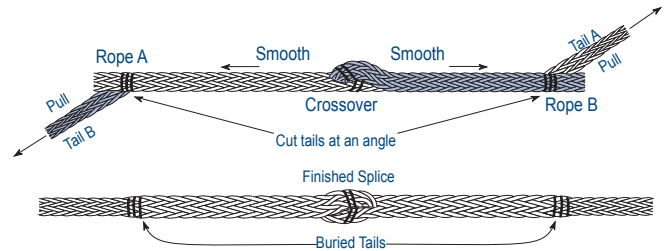

STEP 1

LOCK STITCH PROCEDURE

From Mark 2 at crossover, count 8 picks in either direction and insert stitching twine.

STEP 2

Working towards the crossover, pass end "B" back and forth through splice until a minimum of 3 complete stitches have been made on each side of crossover.

2A Tie an overhand knot in each tail, as close to its exit point as possible.

2B Insert tail of stitching twine at exact location where twine emerges. Using needle or small fid, pull (or push) through rope at a slight angle. Pull hard on the end of the twine so that the knot disappears inside the rope. Trim off the remaining twine close to the rope.

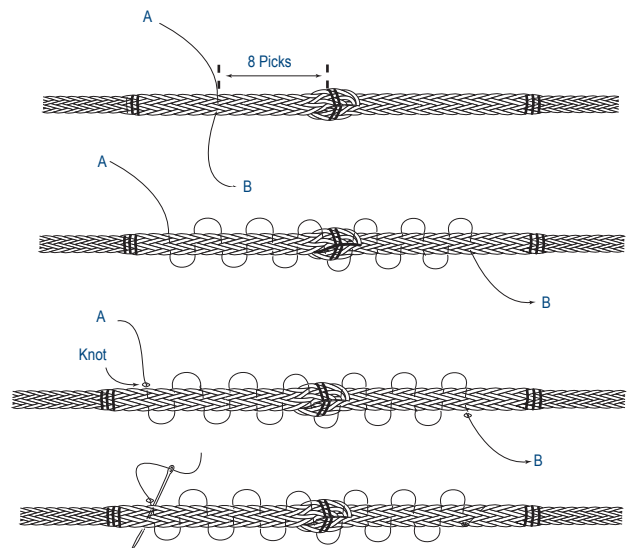



SATURN-12 TUCK-BURY SPLICE 12-STRAND

This is a modification to the standard HMPE Tuck-Bury 12-strand splice to increased splice length on Saturn-12. This modification must be used on Saturn-12 products over 1.5" in diameter.

Additional rope needed for splice:
2-1/2 fid lengths plus length of eye;
with thimble: 2-1/2 fid lengths plus
1/2 circumference in feet.

STEP 1

MEASURE AND MARK

Tape end to be spliced. Then measure 2 fid lengths from the bitter end and mark. This is Mark 1. Wrap tape tightly around the rope at Mark 1.

1A From Mark 1, form a loop the size of the eye desired and mark. This is Mark 2.

1B From Mark 2, measure down the rope 2-1/4 fid lengths and mark. This is Mark 3.

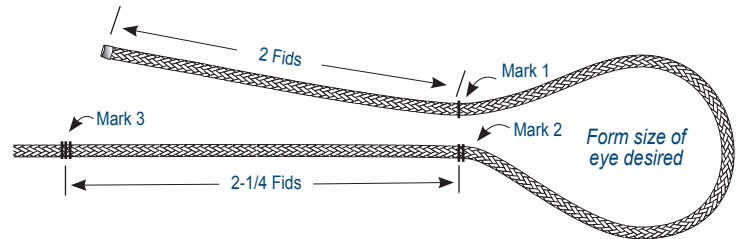

STEP 2

TAPER THE TAIL

At Mark 1, pull out half the strands (three "S" and three "Z") by rotating around the rope, pulling out strands in the pattern shown:

Z strand = counterclockwise twist
S strand = clockwise twist

This should leave 6 strands still braided down the middle. Tightly tape the ends of the 6 individual strands, and the end of the remaining braided portion.

2A On one side you should have two "S" strands and one "Z" strand and two "Z" strands and one "S" strand on the other side.

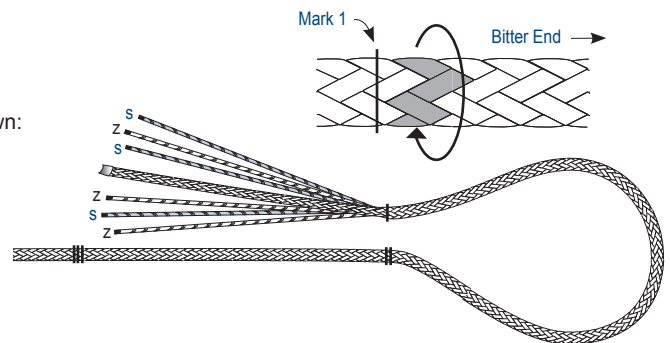

STEP 3

BURY THE TAIL

3A Pass the 3 strands closest to Mark 2 through the rope at Mark 2. Do not pull strands all the way through at this stage.

3B With all 6 strands that are still braided, start to bury them down the center of the rope, entering at Mark 2 and exiting at Mark 3. The tail should enter the standing part at the same point where the 3 strands pass through the rope. Pull the tail out until Marks 1 and 2 meet. Taper the end of the tail by cutting it across at a 45-degree angle.

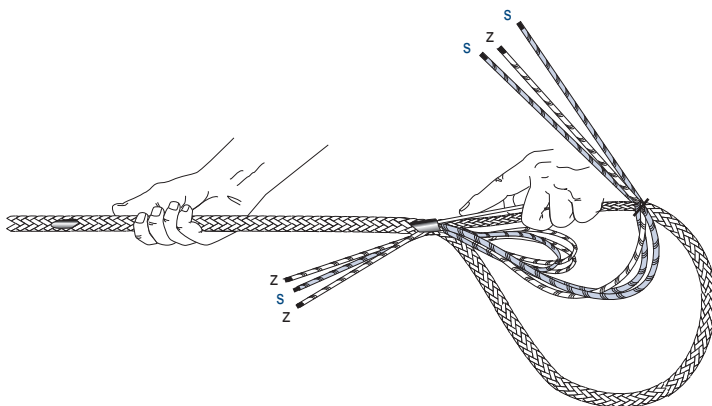
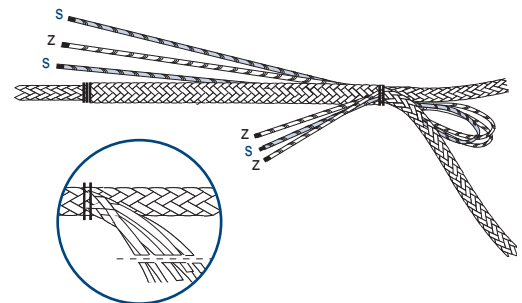
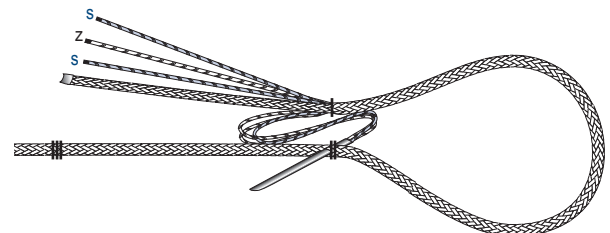



SATURN-12 TUCK-BURY SPLICE 12-STRAND

3C Smooth the bunched line away from the eye. The braided portion of the tail should disappear into the standing part of the line.

3D When the braided section is buried, make sure that the 3 strands that have been passed through the rope are all the way through, with no slack in the strands.

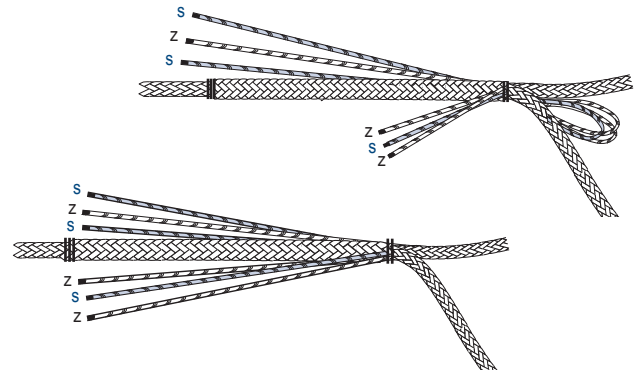

STEP 4

TUCK THE STRANDS

Start the tuck splice the same way as a standard tuck splice. One complete tuck consists of passing a strand over 1 strand and under 2 strands.

4A Do 5 complete tucks for all 6 strands. Each strand is always tucked under the same line of the braid so that the tucks progress straight down the body of the rope.

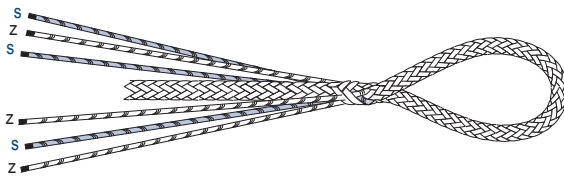

4B After completing the first 5 tucks, remove half of the length of the twisted yarns from each of the 6 strands near the taped ends and complete 3 more tucks with the shortened strands.

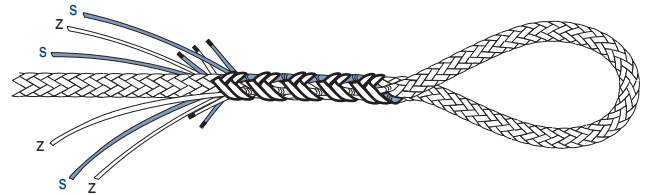

STEP 5

FINISH THE SPLICE

After completing the 2nd set of 3 tucks, cut off the excess material and tape the ends. Leave enough of an end protruding so that the end does not slip back into the rope when the rope is loaded.





END-FOR-END TUCK-BURY SPLICE 12-STRAND CLASS II

The Tuck-Bury splice is designed as a short splice for Class II 12-strand ropes only.

Additional rope needed for splice:
 1-3/4 fid lengths plus length of eye;
 with thimble: 1-3/4 fid lengths plus
 1/2 circumference in feet.

STEP 1

MEASURE AND MARK

Tape the ends of the ropes to be spliced. Lay the Ropes A and B side-by-side and measure 1-1/2 tubular fid lengths, (if using a wire fid, measure three fid lengths because wire fids are half size) from the taped end of each line and make Mark 1.

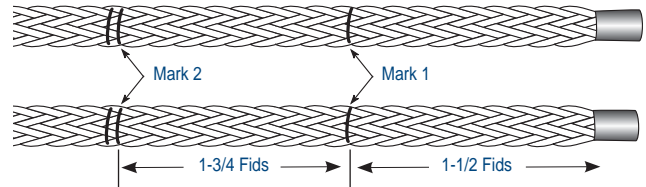

1A From Mark 1, measure 1-3/4 fid lengths and make Mark 2 on both lines.

STEP 2

TAPER THE TAILS

At Mark 1, pull out 3 "S-strands" and 3 "Z-strands" (half the strands) by rotating around the rope, pulling out strands in the pattern shown in the picture.

Z-strand = counterclockwise twist
 S-strand = clockwise twist

This should leave six strands still braided down the middle. Tightly tape the ends of the six individual strands, and the end of the remaining braided portion.

You should have two S-strands and one Z-strand on one side and two Z-strands and one S-strand on the other side.

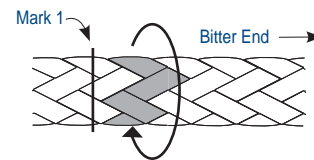

STEP 3

REPOSITION THE ROPES

Reposition the ropes for splicing according to the diagram.

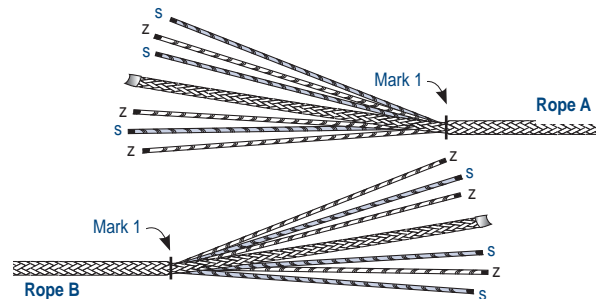

STEP 4

BURY THE TAIL OF ROPE A INTO ROPE B

From Rope A, pass the three closest strands to Rope B through Rope B one or two picks down from Mark 1. Do not pull strands all the way through at this stage.

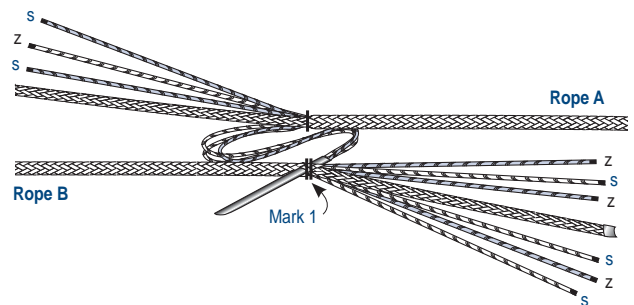

4A Bury the remaining braided strands down the center of the rope, entering at Mark 1 and exiting at Mark 2. The tail should enter the standing part of the rope at the same point where the three loose strands passed through. Pull the tail out at Mark 2.

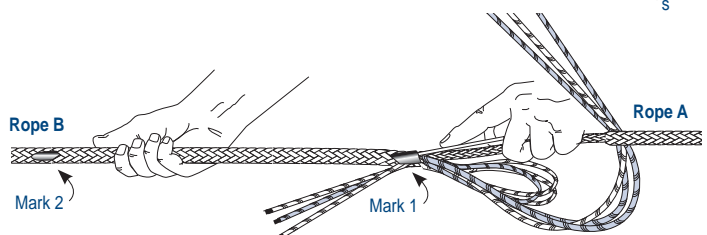



END-FOR-END TUCK-BURY SPLICE 12-STRAND CLASS II

STEP **5**

TAPER THE TAIL

Pull tails to tighten crossover. Then, smooth braid in both directions away from the crossover. Now cut off tails—Taper end of tail by cutting across at 45° angle.

Give a final smoothing, away from crossover, stroking rope firmly. Tails should bury inside cover.

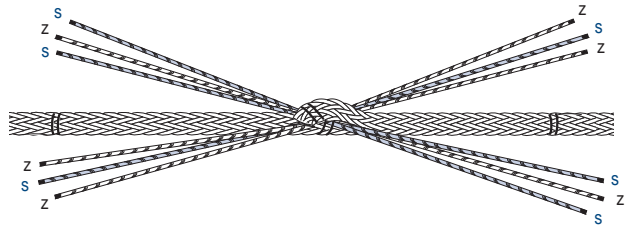
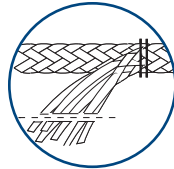
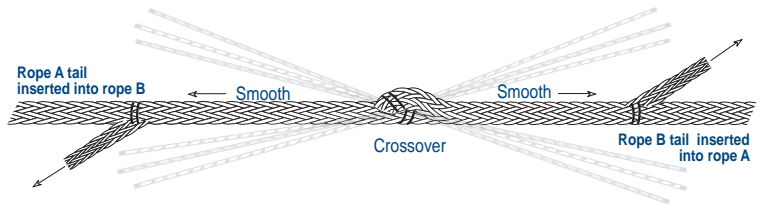

STEP **6**

TUCK THE STRANDS

Tuck the strands from Rope A into Rope B. One complete tuck consists of passing a strand over one strand and under two strands.

Do three complete tucks for all six strands. Each strand is always tucked under the same line of the braid so that the tucks progress straight down the body of the rope.

After completing the first three tucks, remove half the volume of the twisted yarns from each of the six strands near the taped ends, and complete three more tucks with the reduced-volume strands.

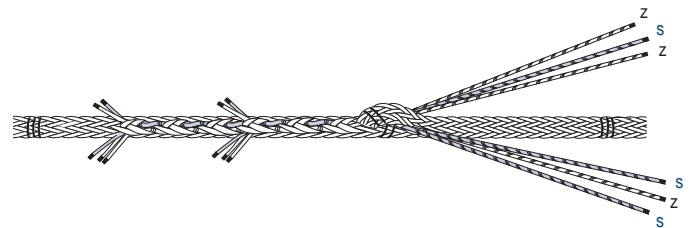
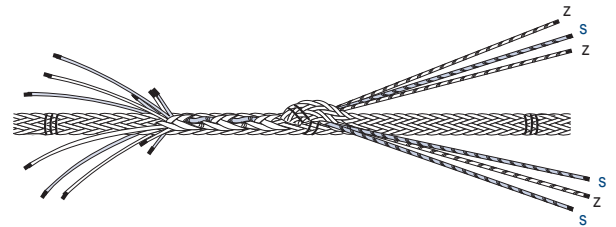

STEP **7**

FINISH THE SPLICE

After completing the second set of three tucks, cut off the excess material and tape the ends. Leave enough of an end protruding so it does not slip back into the rope when the rope is loaded.

Follow Steps 5 and 6 until all tails are tucked.

Your finished Tuck-Bury End-for-End Splice will look like the picture.





TUCK BURY SPLICE 12-STRAND – HMPE ONLY

The Tuck Bury splice is designed as a short splice for HMPE (Dyneema® fiber) 12 strand ropes only.

Additional rope needed for splice:
1-3/4 fid lengths plus length of eye;
with thimble: 1-3/4 fid lengths plus 1/2
circ. in feet.

STEP 1 MEASURING AND MARKING

Tape end to be spliced. Then measure 1-1/2 fid lengths from the bitter end and mark. This is Mark 1. Put tight tape wrap at Mark 1.

1A From Mark 1, form a loop the size of the eye desired and mark. This is Mark 2.

1B From Mark 2, measure down the rope 1-3/4 fids and mark. This is Mark 3.

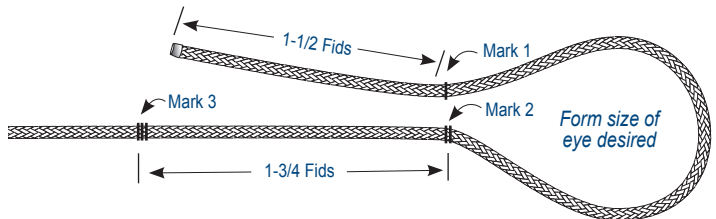

STEP 2 TAPERING THE TAIL

At Mark 1, pull out half the strands (three "S" and three "Z") by rotating around the rope, pulling out strands in the pattern shown:

Z Strand = counter clockwise twist
S Strands = clockwise twist

This should leave six strands still braided down the middle. Tightly tape the ends of the six individual strands, and the end of the remaining braided portion.

2A On one side you should have two "S" and one "Z" and on the other side, two "Z" and one "S".

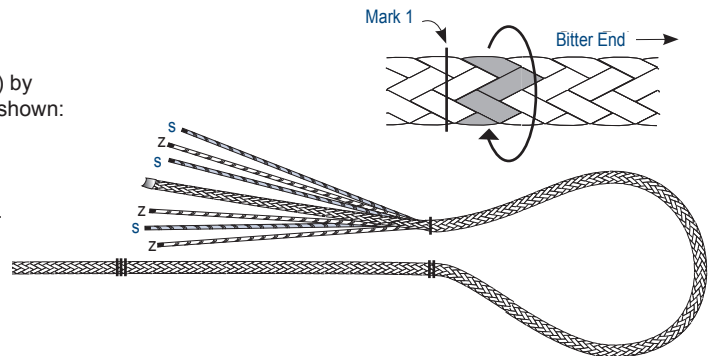

STEP 3 BURYING THE TAIL

3A Pass the three strands closest to Mark 2 through the rope at Mark 2. Do not pull strands all the way through at this stage.

3B With all six strands that are still braided, start to bury them down the center of the rope, entering at Mark 2 and exiting at Mark 3. Tail should enter standing part at the same point where the three strands pass through the rope. Pull the tail out until Marks 1 & 2 meet. Taper end of tail by cutting across at 46° angle.

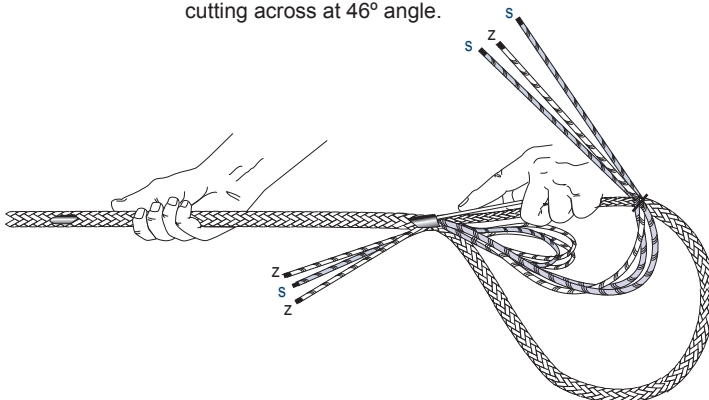
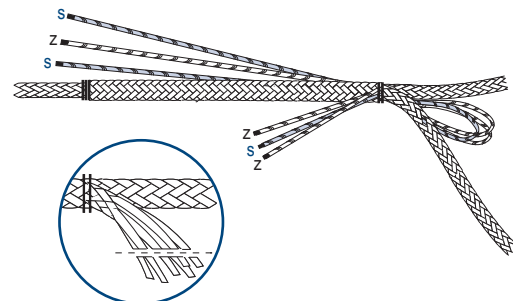
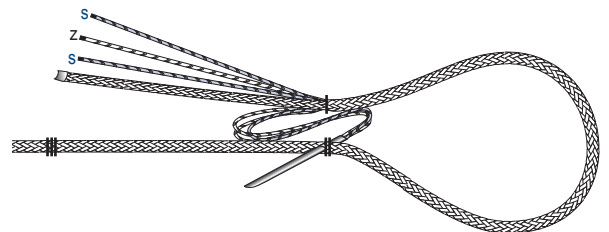



TUCK BURY SPLICE 12-STRAND – HMPE ONLY

3C Smooth bunched line away from eye. The braided portion of the tail should disappear into the standing part of line.

3D When the braided section is buried, make sure that the three strands that have been passed through the rope are all the way through, with no slack in the strands.

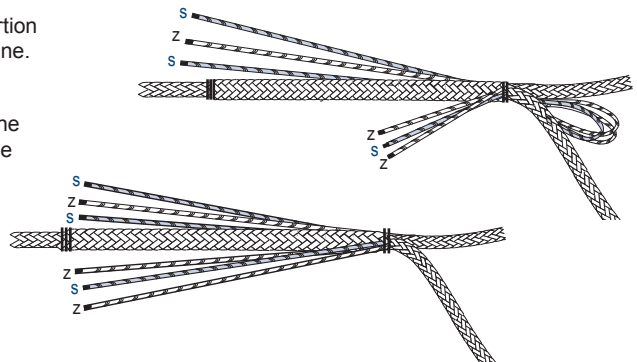

STEP 4

TUCKING THE STRANDS

Start the tuck splice the same way as a standard tuck splice. One complete tuck consists of passing a strand over one strand and under two strands.

4A Do three complete tucks for all six strands. Each strand is always tucked under the same line of the braid so that the tucks progress straight down the body of the rope.

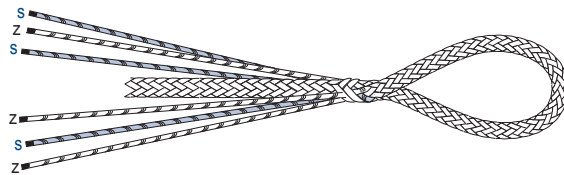

4B After completing the first three tucks remove 1/2 of the volume of the twisted yarns from each of the six strands near the taped ends and complete three more tucks with the reduced volume strands.

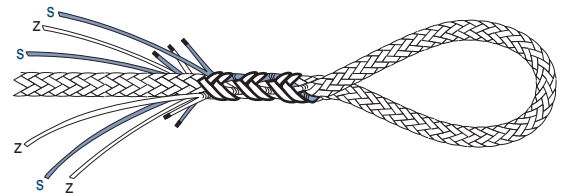

STEP 5

FINISHING THE SPLICE

After completing the second set of three tucks, cut off the excess material and tape the ends. Leave enough of an end protruding so that the end does not slip back into the rope when the rope is loaded.

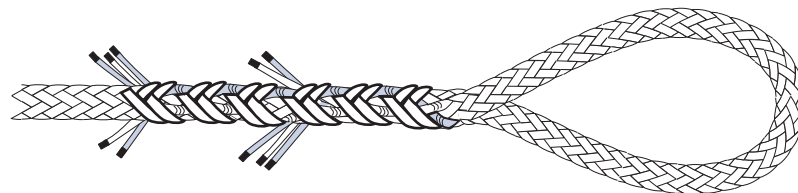



WHOOPIE SLING AMSTEEL® & AMSTEEL®-BLUE

AmSteel® and AmSteel®-Blue Whoopie Slings have a break strength of 60% of the published average ROPE break strength.

All slings use the same measurements with proper size fid.

CUT LENGTHS FOR SLINGS:

Rope Size	Cut Length	Sling Adjusts From/To
1/2"	17.5'	5.5' to 8'
5/8"	20'	7' to 9'
3/4"	24'	7.5' to 10'

NOTE: For longer sling lengths, determine length needed beyond the maximum length listed above. Multiply the length needed by 2 and add resulting amount to cut length. For example: If you need a maximum length of 12 ft. on a 3/4" sling, this is 2 ft. longer than the listed max length. Multiply 2 ft. x 2 = 4 ft. Add this to the original cut length (4 ft. + 24ft. = 28ft.). Your cut length will need to be 28' to make a sling that adjusts to 12'.

STEP 1

SPLICING FIXED EYE

Using these measurements do the **Locked Brummel Splice**. Directions are as follows...



1A Leave tail at full volume. Just cut end at an angle, then tape.

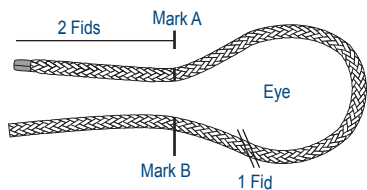

1B Pass end through center of rope at Mark B. Do not bury Mark A, leave on entry side of standing rope.

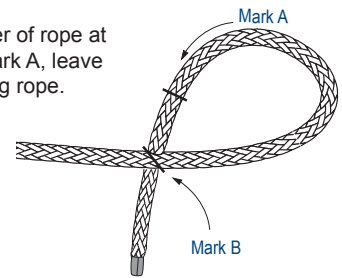

1C Pass the opposite end through the center of the tail approximately 2 picks from where it exits the standing rope.

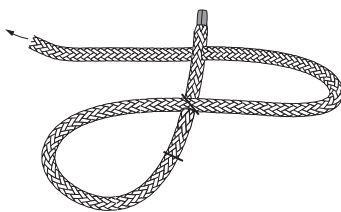

1D Close up Brummel.

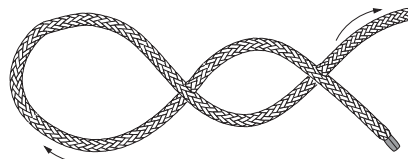

1E To bury the tail into the standing end, make a mark approximately 2 picks from where the standing part passes through the tail (Mark C). This will be the tail entry point. From Mark C, measure down the standing part 2-1/4 fid lengths and make Mark D. Insert fid and tapered tail at C and bring out at D. Remove fid and smooth the standing part out, which will bury the entire tail.

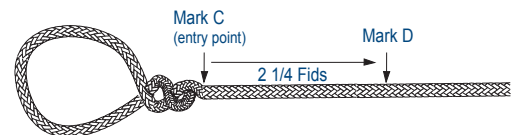

STEP 2

CREATING ADJUSTABLE LOOP

2A From Mark D measure 3-1/2 fids and make Mark E.

2B Attach end of rope to a fid and pass the fid and tail in at Mark E and out of Mark D. Pull the tail end through the buried portion and leave the tail exposed.

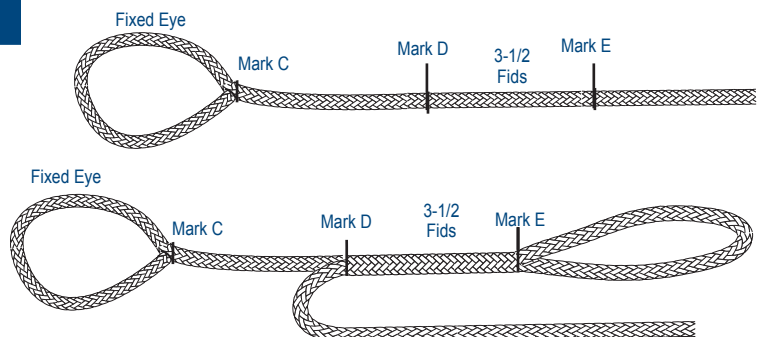



WHOOPIE SLING AMSTEEL® & AMSTEEL®-BLUE

STEP 3

BACK SPLICING THE END

From the unspliced end of the rope, measure 1/2 fid then measure a fid short section. Use these marks to do a Back Splice as follows:

3A Insert the end of the rope in at the 1/2 fid mark and out at the short section mark.

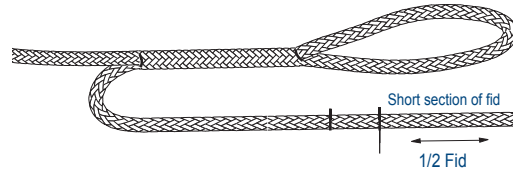

3B Pull firmly on the tail until the "eye" completely closes.

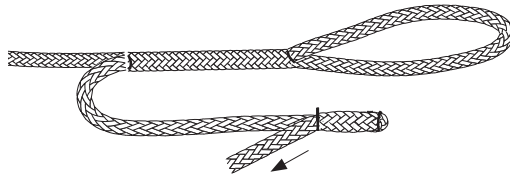
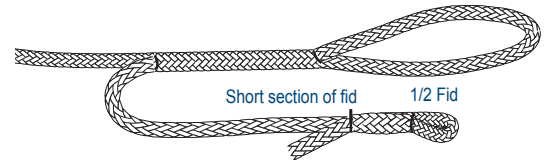

3C Grasp the "butt" of the splice and milk back towards exit point.

3D Mark the tail at the exit point. Pull the tail out slightly and cut off at an angle.

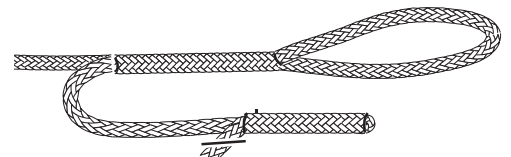
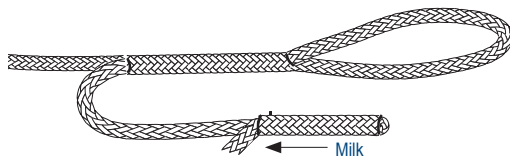

3E Re-milk to bury tail.



COMPLETED WHOOPIE SLING



EYE SPLICE DOUBLE BRAID CLASS II

Class II (core-dependent) double braids are made in whole or part from any of the following high modulus fibers: Dyneema®, Vectran®, Technora®, and Zylon®.

The eye splice is used to place a permanent loop in the end of a rope, generally for attachment purposes to a fixed point. An eye is also used to form the rope around a thimble, which is used to protect the rope, especially when it is to be attached to a shackle, chain or wire rope.

The following procedure is intended to preserve the strength of double braided rope constructions where the rope's core is the primary strength member.

Additional rope needed for splice:
 2-1/2 fid lengths plus length of eye:
 with thimble: 2-1/2 fid lengths
 plus 1/2 circ. in feet.
 (for AmSteel II Plus, 3 fid lengths.)

STEP 1

MARKING THE COVER

1A Measure 2 tubular fid lengths back from end:
 Place Mark 1 on cover and on core.
 (for AmSteel II Plus, the required bury length is 3 fids.)

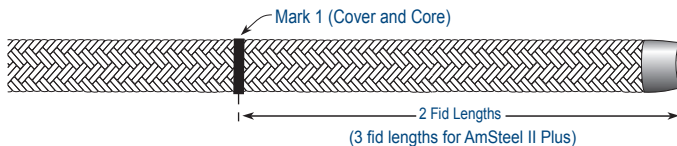

Measure eye size back from Mark 1 and place Mark 2 on both the cover and core, as done with Mark 1.

When splicing on a thimble with ears, slide thimble on and position between Mark 1 and Mark 2. Leave in place and continue with the splice. Thimble must be positioned between "X" points. (1B)

1B Mark on cover two extraction points (X), as measured by the "Z" length toward end of rope from Mark 1 and Mark 2.
 (8 fid lengths for AmSteel II Plus.)

1C Put slipknot in rope six fid lengths back from Mark 2.
 (8 fid lengths for AmSteel II Plus.)

Length of Z Section Based On Size of Rope as Follows:

Size (Dia.)	1/4"	5/16"	3/8"	7/16"	1/2"	9/16"	5/8"	3/4"	7/8"	1"	1-1/8"	1-1/4"	1-5/16"	1-1/2"
Z Length	5"	5"	5"	5"	6"	6-3/4"	7-1/2"	8"	9"	9"	12"	12"	13"	13"
AmSteel II Plus	6-1/2"	6-1/2"	6-1/2"	6-1/2"	8"	9"	10"	10-1/2"	12"	12"	15"	15"	17-1/2"	17-1/2"

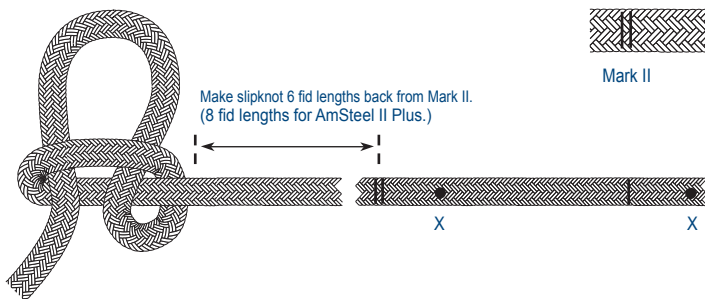
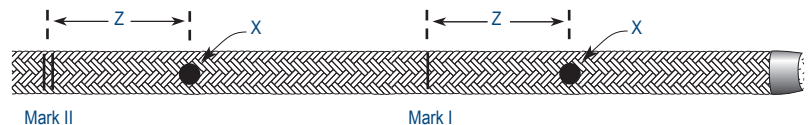

STEP 2

EXTRACTING THE CORE

Extract core at extraction point X nearest end of rope. Put an overhand knot in core at the point where it comes out of the cover.



EYE SPLICE DOUBLE BRAID CLASS II

2A Now extract core at second core extraction point X in the form of a loop. Expose 2-1/2 fids from Mark 2 and make Mark 3. Extract from same side of rope as first extraction.
(3-1/2 fids for AmSteel II Plus.)

When using thimble with ears, move rope around thimble to expose second extraction point.

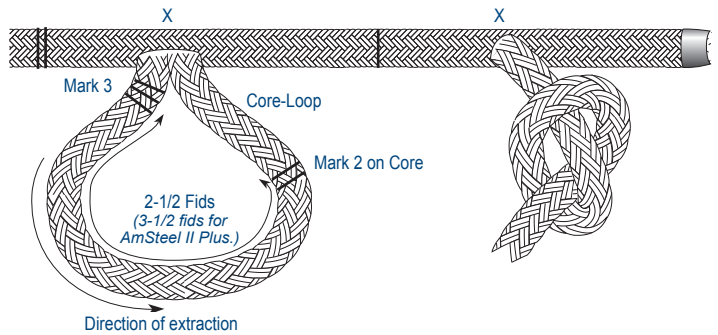

STEP 3 INSERTING CORE INTO CORE

Remove knot in core and insert core-tail into core loop at Mark 2 for 2-1/2 fid lengths. Pull core-tail through until Mark 1 on core meets Mark II on core-loop. Keep these marks together by inserting pusher through both marks.
(3-1/2 fids for AmSteel II Plus.)

Taper core tail by unbraiding core tail from end back to Mark 3. Angle cut strands to perform a taper. Smooth out slack away from Mark 2 on core-loop toward Mark 3, which will cause core tail to disappear into core-loop.

Remove pusher (inserted earlier to keep Mark 1 and Mark 2 together).

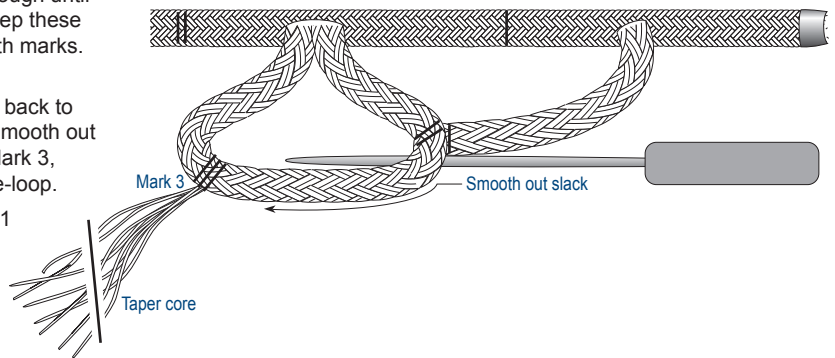

STEP 4 SMOOTHING COVER

Milk up cover completely away from slipknot and toward eye. This should bring cover up to Mark I and Mark II on core (a little over is acceptable).



4A Smooth out cover slack around eye. Extraction points X should close in and meet (a little long will not matter).

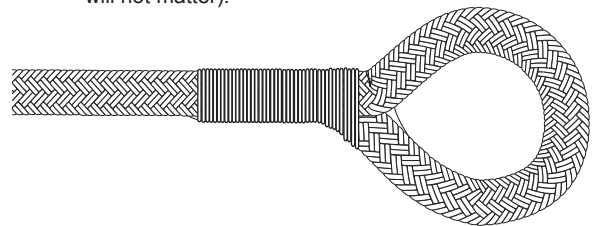

STEP 5 FINISHING THE SPLICE

Bring cover-tail down on side of rope (minimum 2 times rope circumference in inches) and lock stitch (or tape) excess cover to rope. After lock stitching, excess cover should be whipped to the neck of the rope with appropriate whipping twine.



END FOR END DOUBLE BRAID CLASS II

Class II double braid ropes are made in whole or part from any of the following high modulus fibers: Dyneema®, Vectran®, Technora®, or Zylon®.

Additional rope needed for splice:
5 fid lengths.

STEP 1

MARKING THE MEASUREMENTS

From the end of **each** rope, measure and mark as follows:

- A. 2 Fid Lengths from end – Mark 1 on Cover and Core
- B. From Mark 1 measure Z section lengths towards end of rope. (Mark cover only).

LENGTH OF Z SECTION BASED ON SIZE OF ROPE AS FOLLOWS:

Size (Dia.)	1/4"	5/16"	3/8"	7/16"	1/2"	9/16"	5/8"	3/4"	7/8"	1"	1-1/8"	1-1/4"	1-5/16"	1-1/2"
Z Length	5"	5"	5"	5"	6"	6-3/4"	7-1/2"	8"	9"	9"	12"	12"	13"	13"

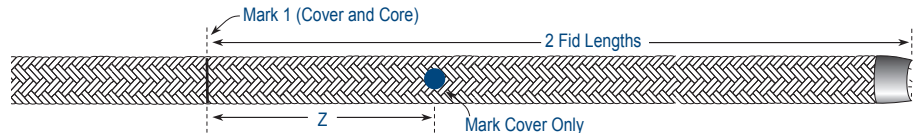

STEP 2

KNOT AND POSITION

Measure back 6 Fid Lengths from Mark 1 and knot or spike each rope. Position ropes as shown.

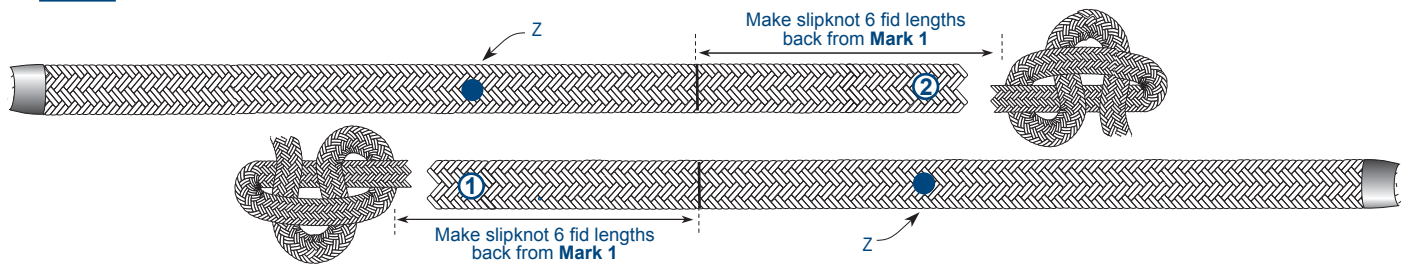

STEP 3

EXTRACT AND MARK CORES

Extract cores at Z Marks, pull out completely from the ends of the ropes. Tape core ends. Slide covers back toward knots/spikes, enhance Mark 1 on each core. Measure 2-1/2 Fid lengths from core Mark 1 towards knots/spikes and make core Mark 2 on each core.

Extracting the core: Bend rope sharply at Z. With the pusher or any sharp tool such as an ice pick, awl, or marlin spike, spread the cover strands to expose core. First pry, then, pull the core completely out of cover.

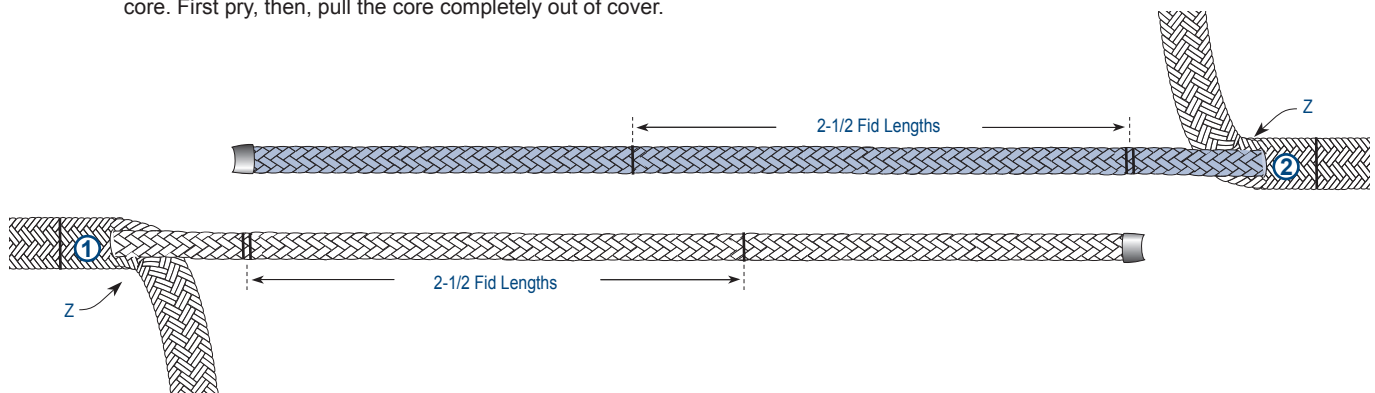
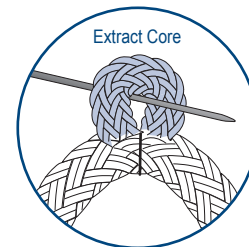



END FOR END DOUBLE BRAID CLASS II

STEP 4

BURYING CORES

Insert the end of each core into the opposing core at Mark 1 and out at Mark 2. Inserting the core ends 1 pick down from Mark 1 on the entrance side of each core allows for a smoother crossover.

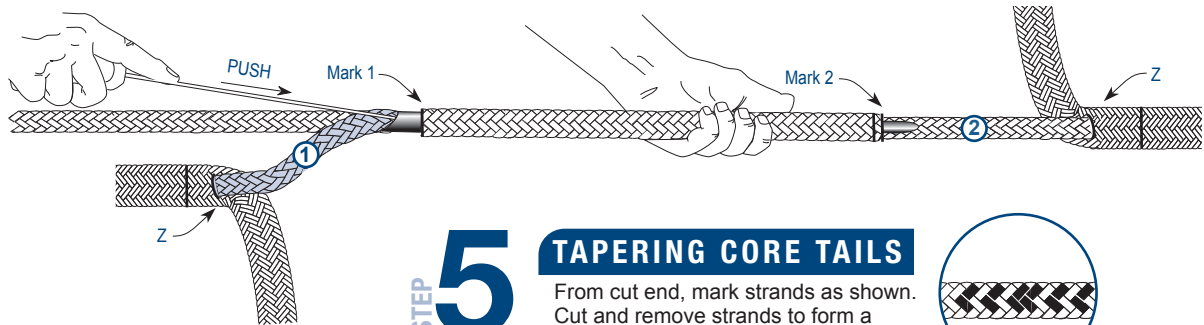

STEP 5

TAPERING CORE TAILS

From cut end, mark strands as shown. Cut and remove strands to form a tapered tail.

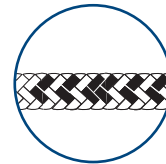

STEP 6

TIGHTEN CROSSOVER

Tighten crossover by milking towards the crossover from each direction.

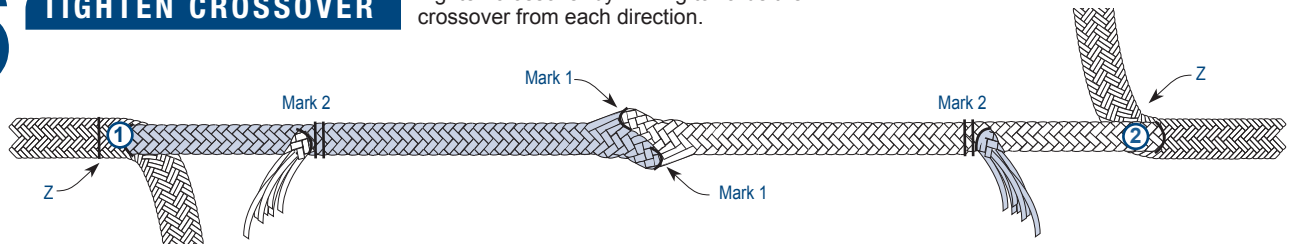

STEP 7

RECOVERING CORE

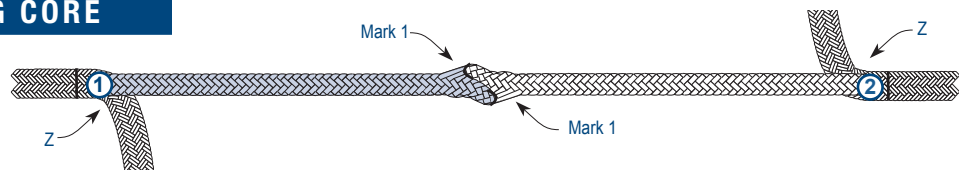

7A Milk away from the crossover in both directions. Tapered tails will disappear. Repeat until all slack is removed, the crossover and entire splice length should be smooth.

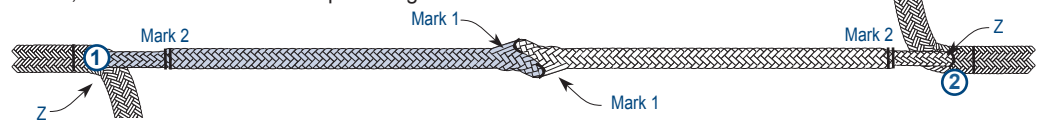

7B Milk the cover towards the crossover. Work one side at a time, hand tensioning the core splice area while working the cover up over it. Covers should meet at or near the crossover. Lock stitch and whip each side of crossover and through cover tails (see eye splice instructions).

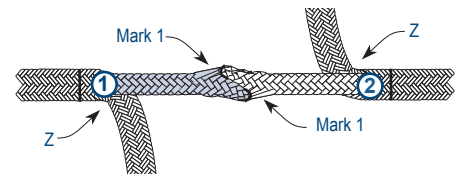

STEP 8

LOCK STITCH AND WHIP

Lock Stitch

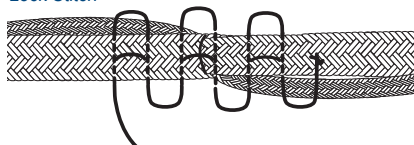

Whipping





STRIPPING COVER DOUBLE BRAID CLASS II

Class II core-dependent double braids are made in whole or part from any of the following high modulus fibers: Dyneema®, Vectran®, Technora®, and Zylon®.

Many high performance sailors like to strip the cover from the core to save weight aloft for halyard applications. In simple terms, you want to strip the cover from the core up to the area of the stoppers, cleats and winches. Leave the cover on the core wherever you have to cleat or winch the rope. The following is a simple, step-by-step method of stripping the cover and finishing the transition area where the cover ends and the core continues.

STEP 1 MARK & KNOT Mark a dot on the cover in the area where you want the core to be exposed.

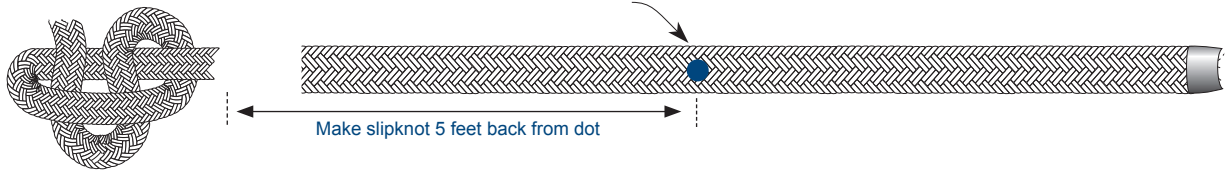

STEP 2 Tie a knot with a loop about 5 feet back from the dot on the cover.

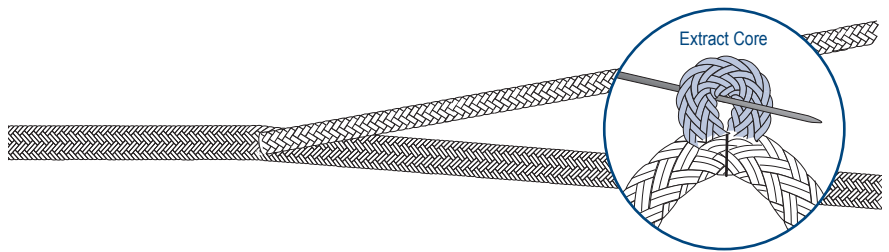

STEP 3 EXTRACT CORE Extract the core from the cover at the dot. Extracting the core: Bend rope sharply at extraction point. With the pusher or any sharp tool such as an ice pick, awl, or marlin spike, spread the cover strands to expose core. First pry, then, pull the core completely out of cover.

STEP 4 SLIDE & MILK COVER Slide the cover back toward the knot, then milk the cover from the knot to the core to balance the cover and the core.

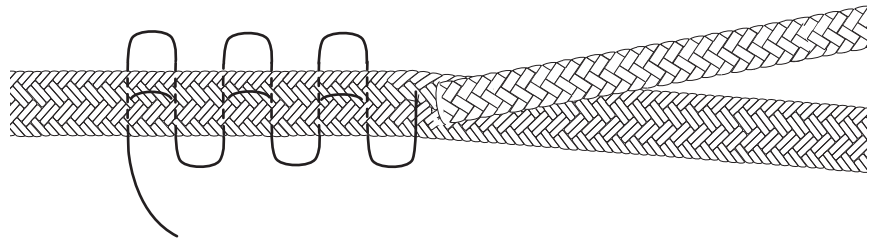

STEP 5 LOCK STITCH Lock stitch the cover to the core from the dot back for about 3 complete passes.

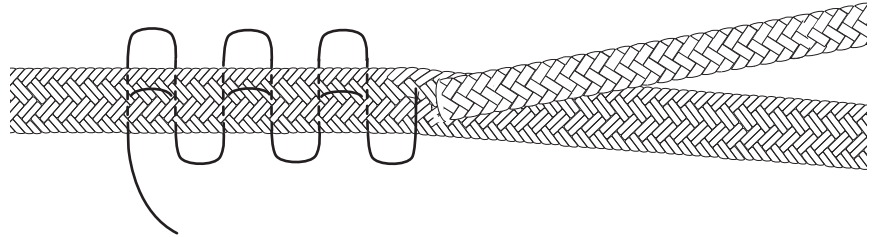

STEP 6 MEASURE & MARK COVER From the point of the lock stitch toward the end of the cover material, measure 6 inches and mark. This will be Mark 1 on the cover.

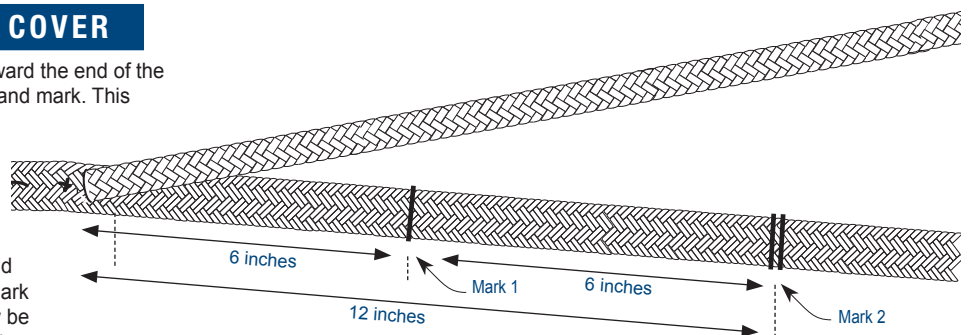

STEP 7 From Mark 1 measure 6 inches and make another mark. This will be Mark 2 on the cover. Mark 2 should now be about 12 inches from the lock stitch.



STRIPPING COVER DOUBLE BRAID CLASS II

STEP 8

Cut off the cover at Mark 2 and discard the rest of the cover material.

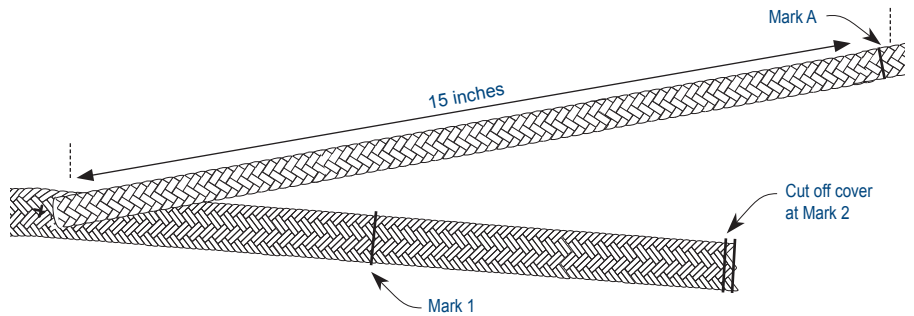

STEP 9

MARK CORE

From the front of the lock stitch toward the end of the exposed core, measure 15 inches and put a mark on the core. This will be Mark A on the core.

STEP 10

COVER INTO CORE

Insert a splicing fid with the cover into the core as close to the lock stitch as possible. Continue pushing the fid through the center of the core and extract the fid and cover at Mark A on the core.

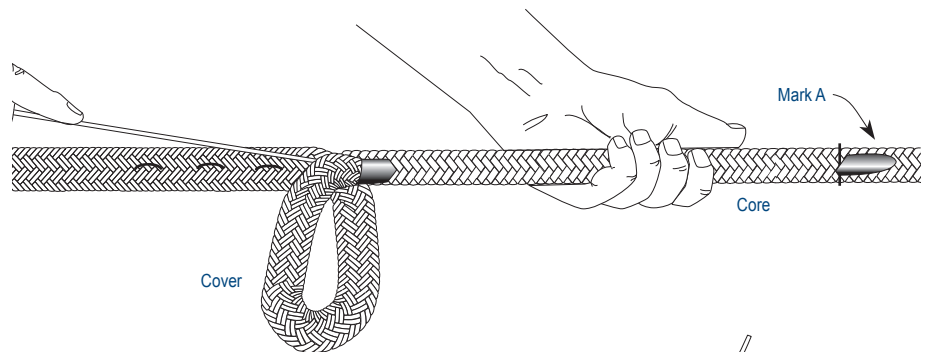

STEP 11

UNBRAID COVER

Pull the cover out of the core until Mark 1 on the cover is exposed. Unbraid the cover from the end back to Mark 1 on the cover. Angle-cut strands from Mark 1 to the end of the cover to perform a taper.

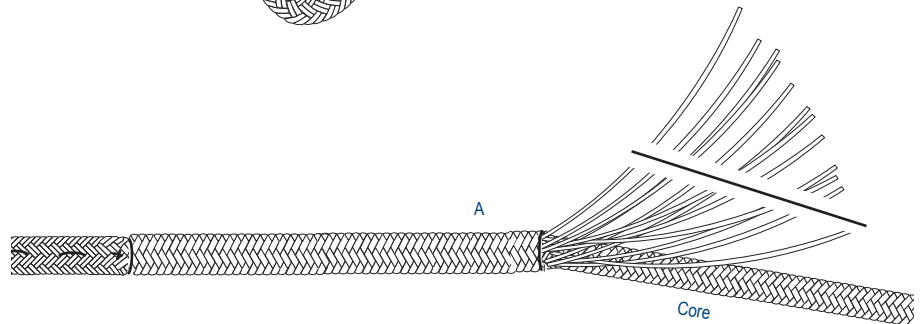

STEP 12

MILK THE CORE

At the point of cover insertion into the core, milk the core down toward the end of the cover. This will cause the cover to disappear into the core.



STEP 13

WHIPPING

Whip the area where the cover is inserted into the core, to finish.

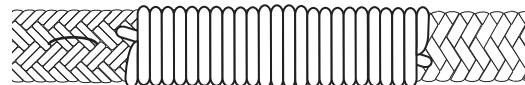



SPECIAL TIPS FOR SPLICING DOUBLE BRAID

SPLICE WITH THIMBLE

Follow Step 1 of the Eye Splice Double Braid Class I for determining the correct eye size. When burying exposed core, as in Step 8, bury to crossover, then insert thimble into eye before milking cover all the way. If using a thimble with ears, before inserting cover into core, as in Step 5, insert core through the rings (dog ears) and slide thimble beyond Mark 3. Then proceed to make the splice according to instructions. Note: Before final burying, slide thimble around to cover side of eye. To secure finished eye tightly around thimble, either whip throat or dip the eye in hot water for several minutes. Hot water will shrink eye tightly around thimble for nylon and polyester fiber ropes.



MINIMUM LENGTHS

Minimum Eye and Eye Sling length with Class I Double Braid is 5 fid lengths from extraction Mark X to extraction Mark X, regardless of rope diameter. The size of eye does not affect the minimum length. Proceed to make the eye splice as per instructions.

Exact Overall Lengths with eye splices are determined by allowing for extra rope consumed in making the splices. For each splice the length of extra rope is equal to 1-1/2 fid lengths plus 1/2 the circumference of the eye.



Example: To make an Eye and Eye Sling 10' overall with two 6" eyes:



Measure and cut a length:

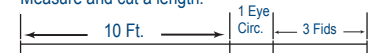

Then start with step #1 of class 1 double braid splice.

END FOR END SPLICE

Minimum Endless Loop (Grommet) with Class I Double Braid is 10 fid lengths between extraction Mark X to extraction Mark X, regardless of rope diameter. Proceed with the Class I Double Braid End for End splicing instructions.

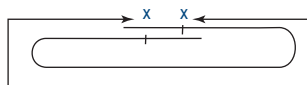

Exact Overall Lengths with endless loops are determined by allowing for extra rope consumed in making the End-for-End Splice. The length of extra rope is equal to 4 fid lengths.

Example: To make an endless loop 10 feet overall:

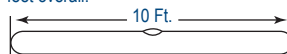

Measure and cut a length:

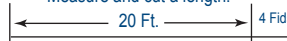

Then start with step 1 of the Class I Double Braid End-for-End splicing instruction.



SPECIAL TIPS FOR SPLICING USED DOUBLE BRAID

Splicing used rope can be made easier by first understanding the rope condition. Natural shrinkage has occurred caused by water and heat. In addition, the cover yarns have often been abraided. Therefore, by using the technique outlined in the Used Rope Eye Splice for Class I Double Braids, along with the following tips, you can splice used Braided Rope more easily and with better results.

Soak the section of rope to be spliced in water for several minutes - this lubricates and loosens fibers.

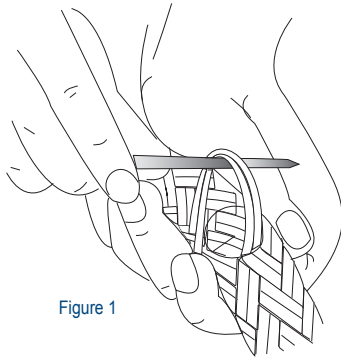

Figure 1

After marking cover (as shown in Step #2 of the splicing instruction) untape end of rope, grasp end of core, and slide back cover pulling out core. This loosens and bunches up cover strands in the area of Point X and makes it easier to open up cover strands for extraction. Also, carefully loosen 3-4 strand pairs at X to assure a large and flexible hole for extraction. (Figure 1)

Final Burying:

The use of a shock cord in a rolling hitch around the cover is useful to make final burying easier and more complete. Pull on the hitch toward the eye until all cover slack is removed. (Figure 2)

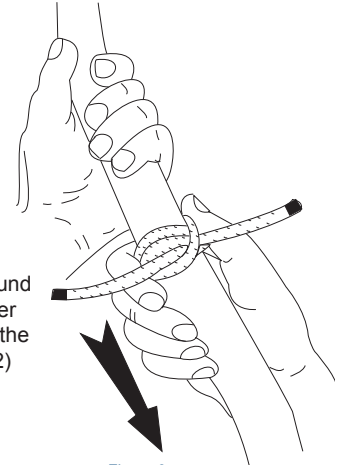

Figure 2



EYE AND EYE TAIL SPLICE

NOTE: These instructions are intended for use with Samson's Tenex, Tenex-Tec (2 end per carrier Tenex), IceTail, or Tech-12 only.

The desired tail length will dictate the starting length of cordage required. For a 33" finished Eye and Eye Tail, an 80" length of 3/8" rope is required.

STEP 1 TAIL LENGTH

Mark the center point of the rope. This is mark A. Bring both ends of the rope towards the center point as shown and overlap the tails 1-1/2"

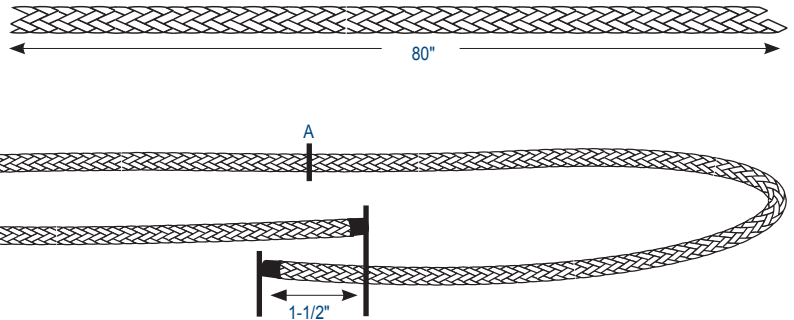

STEP 2 MARK EYE SIZES

Mark the size of the eye on each tail. From the inside of the eye, mark both legs of the eye at 1-1/4". These are marks B and C, as shown.

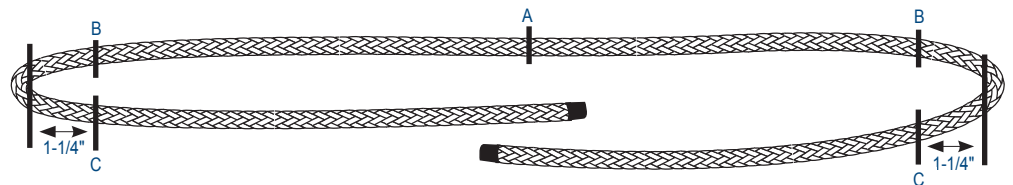

STEP 3 MARK AND PULL TAPERS

Mark the tapers. From mark C towards the ends, count twelve strand pairs and begin taper marks on the thirteenth pair. Mark both a left hand and a right hand strand pair at each point for removal. Mark the 13th, 15th, and 17th. You should have a total of six strand pairs marked for removal at each end. Pull the marked strands from the rope, but do not cut. Replace the tape on both ends of the rope.

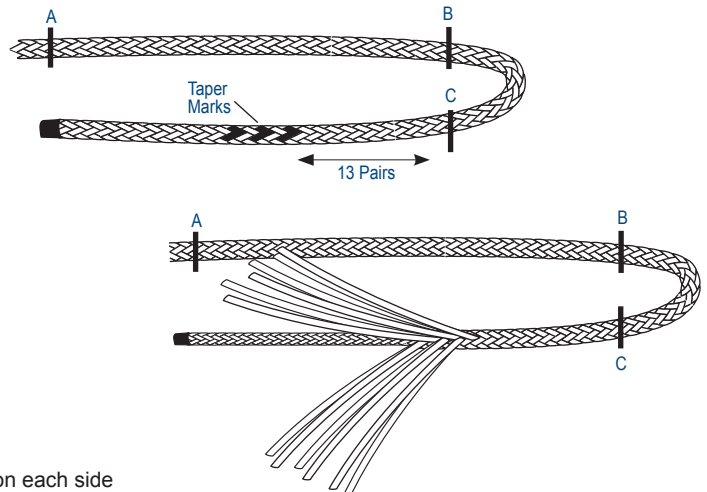

STEP 4 MARK EXIT POINTS

From the midpoint marked in step 1, measure four inches on each side of the center mark and make a mark. These will be the exit points X.

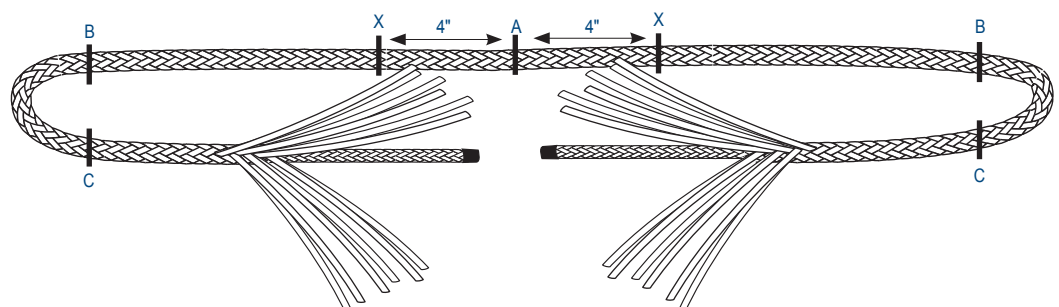



EYE AND EYE TAIL SPLICE

STEP 5 FORM AND CLOSE BRUMMEL

5A Form the locked Brummel on both ends. Pass the shorter taped end through the center of the rope at mark B. Do not bury mark C, leave on the entry side of standing rope.

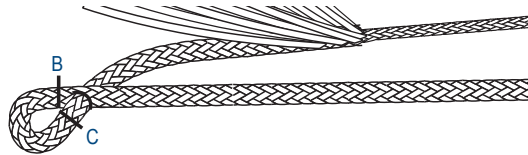

5B Pass the opposite end through the center of the tail approximately two picks from where it exits the standing part of the rope. Close up the Brummel, bringing marks B and C together at the vertex of the eye.

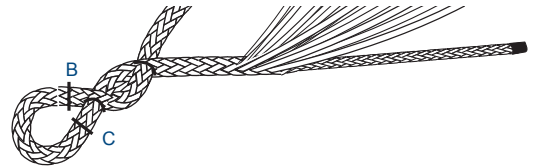

STEP 6 BURY TAILS

Measure 2 picks from the point where the standing part passes through the tail. This is mark D.

With a fid attached to the taped end of the tail, bury the tail from mark D past the midpoint A to mark X. Just before the pulled taper strands are buried into the standing part of the rope, cut them off. Pull the tail out at mark X as far as possible, and repeat steps 5, 6, and 7 for the opposite end.

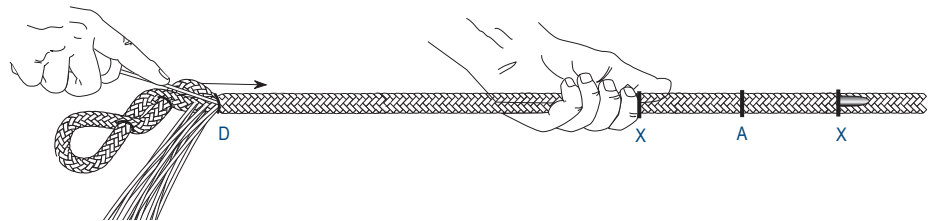
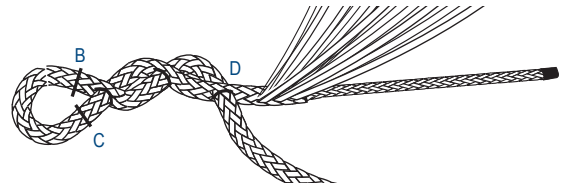

STEP 7 MARK AND CUT ENDS

Smooth all slack from the rope, working from the Brummels to the center mark. Mark where the tapered ends exit the rope at both marks X. Pull both tapered ends out from mark X, measure 3-1/2" from previous mark where the tapers exited at mark X (this is the section of both tapered ends that overlap in the center section), and cut off at an angle.

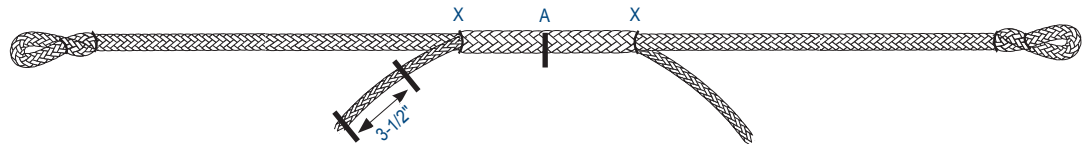

STEP 8 FINISH SPICE

Milk all slack from the Eye and Eye Tail. The goal is to keep the diameter and fullness of the rope consistent tied into a climbing hitch. When all slack has been removed and the diameter is consistent, lock stitch the eyes at both ends.

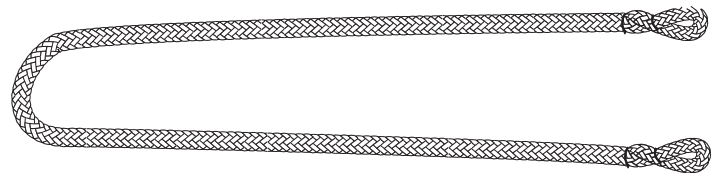



LOCK STITCHING & WHIPPING PROCEDURES

LOCK STITCHING:

STEP 1

Pass stitching through spliced area near throat of eye as shown.

STEP 2

Reinsert as shown pulling snug but not tight.

STEP 3

Continue to reinsert as shown until you have at least 3 complete stitches.

STEP 4

After completing Step 3, rotate spliced part of rope 90° and reinsert end A into spliced area in the same fashion as in Steps 1, 2 and 3. The splice will now be stitched on two planes perpendicular to each other. Make sure you do not pull the stitching too tight.

STEP 5

After stitching at least three complete stitches as in Step 3, extract both ends A and B together through the same opening in the braid. Tie them together with a square knot and reinsert back into braid. For double braids, re-insert the knot between the cover and core.

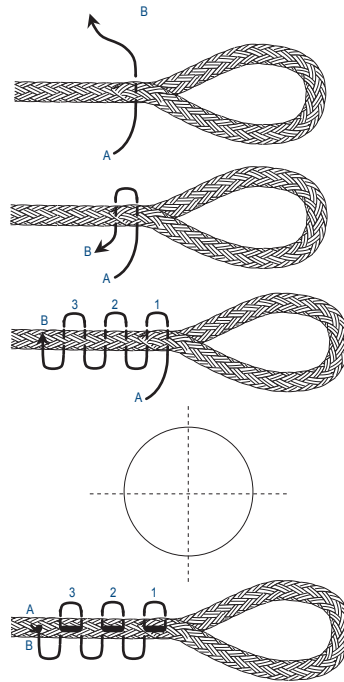

Twines for Lock Stitching:

In general, braided nylon twine is preferred for lock stitching. Polyester twines, or twisted twines in either polyester or nylon, or a strand from the rope itself (from a discarded or extra piece) can be substituted.

The twine used should be approximately the same diameter as a strand in the rope. If the rope or the cover of the rope is made up of pairs of strands rather than a single strand, the twine should be about the same diameter as these two strands together.

To check the twine size, lay the twine over the strands in the rope – if it covers the width of the strand(s), it is the right size.



SAMSON ICE / FLAVORED ICE COVER INSTALLATION

STEP 1

MEASURE AND MARK

Lay out rope to be covered and from the end to be covered, measure off distance to be covered and make Mark 1 on the rope. From Mark 1, measure off a distance of 15 inches and make Mark 2 on the rope.

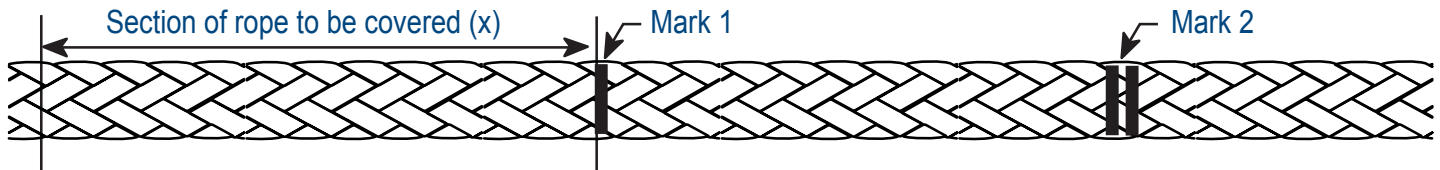

STEP 2

Lay out Ice cover below rope to be covered and allow 15% more cover length than rope to be covered from Mark 1 to the end of the rope. Then make Mark 1 on the cover using Mark 1 on the rope as a guide. Next make Mark 2 and Mark 3 on the cover by measuring off 6 inches for each mark.

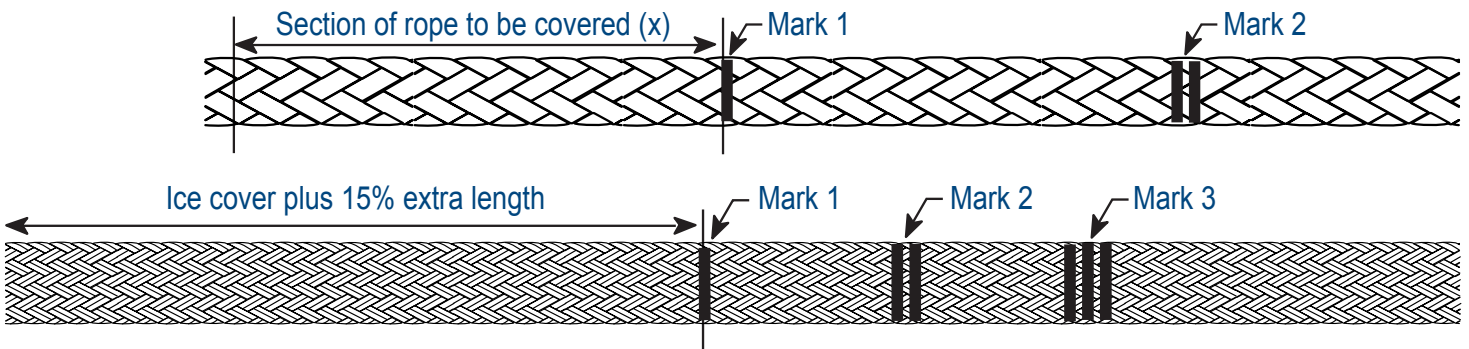

STEP 3

Tape and cut the Ice cover at Mark 3. Then extract the internal feed line from the cover at Mark 1. Attach feed line to rope end to be covered by passing the feed line through the rope braid and forming a loop knot. Be careful not to pull the feed line into the cover on the other end.

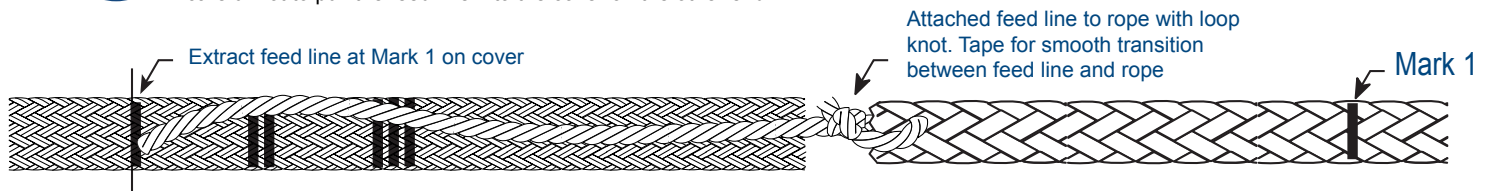

STEP 4

Attach feed line from other end of cover to a fixed point for assistance in burying the rope into the cover.

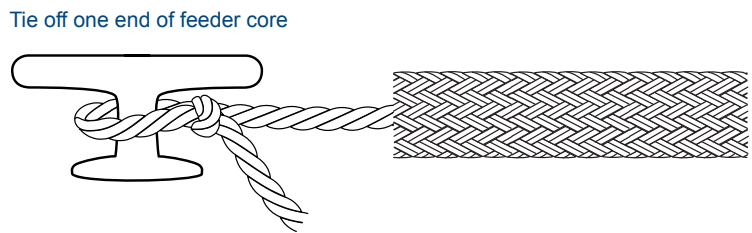



SAMSON ICE / FLAVORED ICE COVER INSTALLATION

STEP 5

Feed rope into cover and milk cover over rope until Mark 1 of cover and Mark 1 of rope are matched. Then lock stitch the cover to the rope from Mark 1 back for 3 complete passes.



STEP 6

Insert a splicing fid, fid should be sized to rope diameter, with the cover into the rope as close to the lock-stitch as possible. Continue pushing the fid through the center of the rope and extract the fid and cover at Mark 2 on the rope.

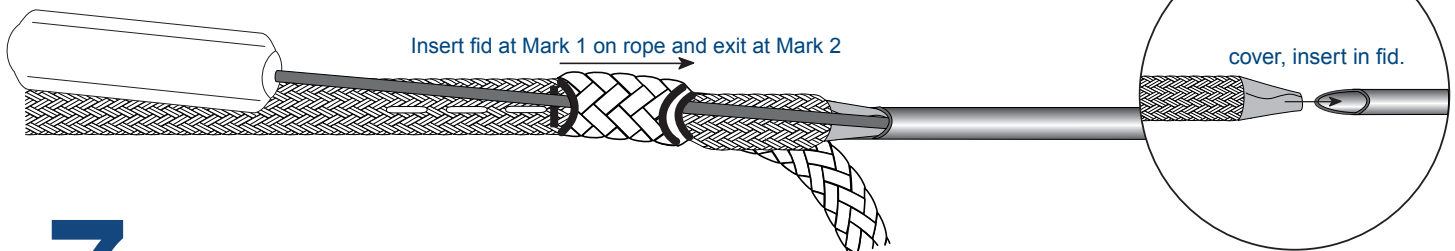

STEP 7

Pull the Ice cover out of the rope until Mark 2 on the cover is exposed. Unbraid the cover from the end back to Mark 2. Angle cut the strands from Mark 2 to the end of the cover to perform a taper.

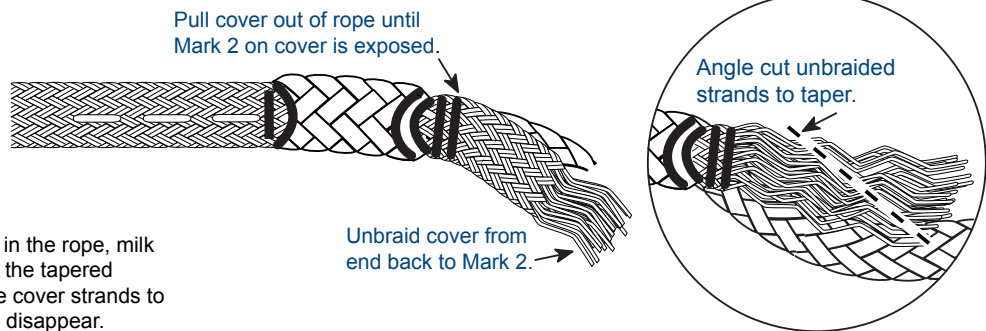

STEP 8

At the point the cover is inserted in the rope, milk the rope down toward the end of the tapered cover strands. This will cause the cover strands to become buried into the rope and disappear.



STEP 9

Whip from the area where the cover is inserted into the rope to just beyond the lock stitching to finish that portion of the splice.

STEP 10

If still secured, remove feed line and secure the rope to a fixed point approximately 3 feet beyond the whipping put on in Step 9. Then from the whipping, milk the cover back away from the whipping end. Do this procedure 2 to 3 times to eliminate any slack between the cover and the rope.

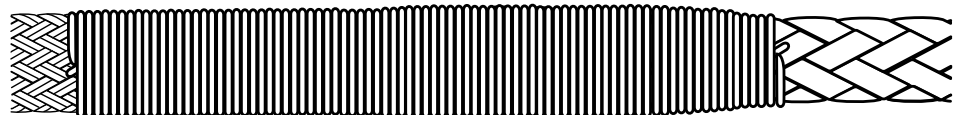

STEP 11

Lock stitch and whip the cover to the rope just before coming to the feed line connection to the rope. At the end of the whipping, cut off excess and the installation is finished.

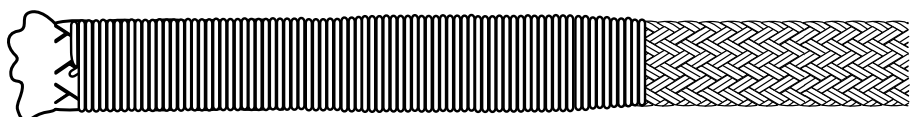



TOOLS & MATERIALS REQUIRED FOR SPLICING

FID:

Samson Tubular, Wire or Selma fids are available in a variety of sizes depending on the rope type and diameter you're splicing.

PUSHER:

Helpful for extracting cores or pushing a fid through the rope.

TAPE:

Masking tape, electrical tape or a similar plastic tape can be used during splicing.

SCISSORS OR KNIFE:

For cutting away strands — must be sharp.

TWINE:

Good quality nylon braided or twisted twine in a size adequate for the rope diameter being spliced. (See pgs. 10 – 13 for sizing twine for whipping and lock stitching.)

RULER OR TAPE MEASURE

MARKING PEN



SPLICING KIT

The Samson Splicing Kit comes with 5 aluminum tubular fids (size range 1/4" through 1/2" diameter)

SPLICING TRAINING KIT

The Samson Splice Training Kit comes complete with a fid, pusher, instructions and 2 lengths of double braided ropes.



WIRE AND ALUMINUM TUBULAR FIDS

Our wire fids are 1/2 scale, meaning that the length of the tool is 1/2 the actual fid length for the corresponding rope diameter.

Tubular Fids are 100% scale, meaning that the overall length of the tool is equal to the actual fid length for the corresponding rope diameter.

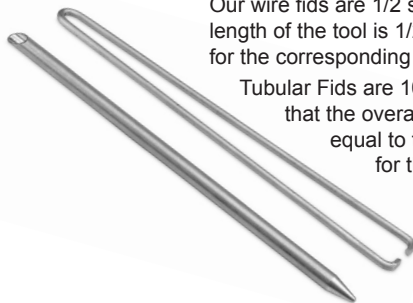

SELMA FIDS

Made from highly polished stainless steel, Selma Fids are patented worldwide. Available in sets only, the Selma Fid may be used to splice hollow braided lines from 1/8" to 9/16" or double braid and 3-strand rope up to 1-1/8".





LOCK STITCHING & WHIPPING PROCEDURES

LOCK STITCHING:

STEP 1

Pass stitching through spliced area near throat of eye as shown.

STEP 2

Reinsert as shown pulling snug but not tight.

STEP 3

Continue to reinsert as shown until you have at least 3 complete stitches.

STEP 4

After completing Step 3, rotate spliced part of rope 90° and reinsert end A into spliced area in the same fashion as in Steps 1, 2 and 3. The splice will now be stitched on two planes perpendicular to each other. Make sure you do not pull the stitching too tight.

STEP 5

After stitching at least three complete stitches as in Step 3, extract both ends A and B together through the same opening in the braid. Tie them together with a square knot and reinsert back into braid. For double braids, re-insert the knot between the cover and core.

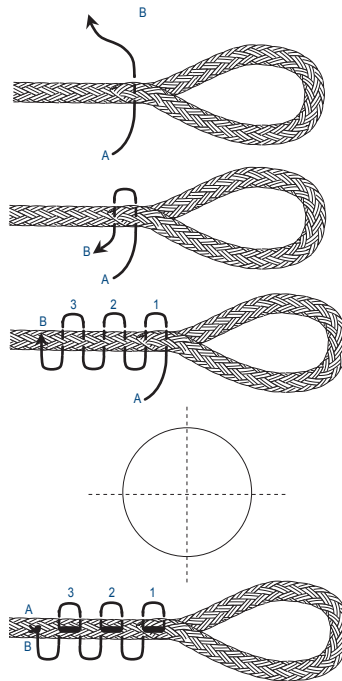

Twines for Lock Stitching:

In general, braided nylon twine is preferred for lock stitching. Polyester twines, or twisted twines in either polyester or nylon, or a strand from the rope itself (from a discarded or extra piece) can be substituted.

The twine used should be approximately the same diameter as a strand in the rope. If the rope or the cover of the rope is made up of pairs of stands rather than a single strand, the twine should be about the same diameter as these two strands together.

To check the twine size, lay the twine over the strands in the rope – if it covers the width of the strand(s), it is the right size.

WHIPPING FINISH SPLICE (METHOD 1)

Whip or seize the end of the spliced area with whipping twine for extra security and a professional touch. Keeping tension on rope while wrapping results in tighter whipping.

STEP 1 Form loop with whipping twine.



STEP 2 Wrap securely at least 1 rope diameter in length.

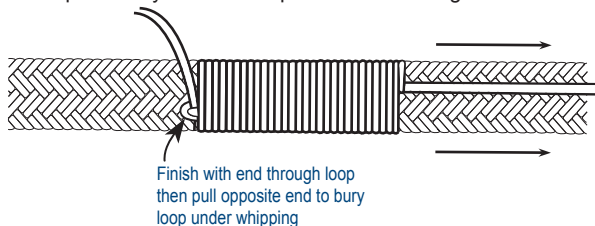

STEP 3 Cut both ends close to whipping.



Choosing twines for whipping:

In general, braided nylon twine is preferred for whipping. Polyester twines, or twisted twines in either polyester or nylon, can be substituted.

The twine used should be approximately twice the diameter of the strands in the rope.



WHIPPING FINISHED SPLICE (METHOD II)

STEP 1

Attach twine to netting needle.

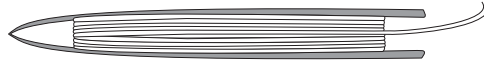

STEP 2

Tape the free end of the twine to the opposite side of the area to be whipped.

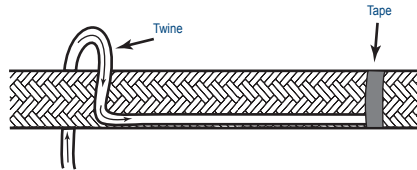

STEP 3

Start whipping. Wrap the needle around the circumference of the rope 1 complete turn. Pass the netting needle under the complete wrap left to right. Pull the loop tight. Pull the needle up maintaining tension on the completed half hitch and then quickly pull back down to lock the half hitch in place.

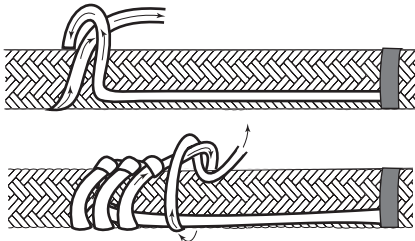

STEP 4

Continue with this procedure until the whipped area is approximately 1/2 of the desired length, then cut the taped free end near the last wrap.

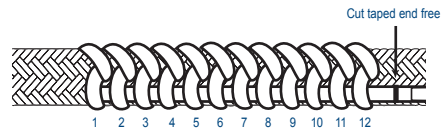

STEP 5

Using some spare twine, tape a loop that covers the length of the intended whipping distance, letting the two free ends of the looped twine pass over the completed whipping. Tape the free ends past the already whipped area.



STEP 6

Continue whipping for the desired length over the top of the looped twine. After whipping is complete, cut less than 1 inch of the exposed whipping twine. Remove the tape on the looped twine and pass the exposed whipping twine through the loop.

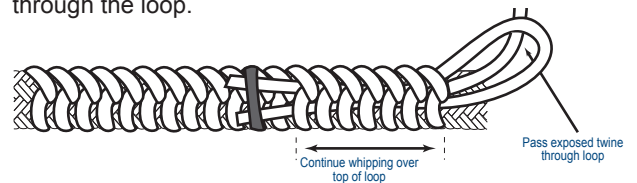

STEP 7

Remove the tape from the two free ends of the looped twine and use them to pull the loop through the whipped area. This should place the remaining whipping twine under the whipped area.



Special Tips for Splicing Used Rope

Splicing used rope can be made easier by first understanding the rope condition. Natural shrinkage has occurred caused by water and heat. In addition, the cover yarns have often been abraided. Therefore, by using the technique outlined in the Used Rope Eye Splice for Class 1 Double Braids, along with the following tips, you can splice used Braided Rope more easily and with better results.

Soak the section of rope to be spliced in water for several minutes - this lubricates and loosens fibers.

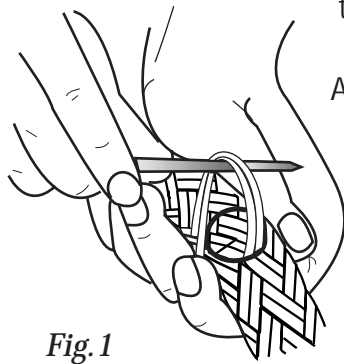

Fig. 1

After marking cover (as shown in Step #2 of the splicing instruction) untape end of rope, grasp end of core, and slide back cover pulling out core. This loosens and bunches up cover strands in the area of Point X and makes it easier to open up cover strands for extraction. Also, carefully loosen 3-4 strand pairs at X to assure a large and flexible hole for extraction. (See Fig.1).

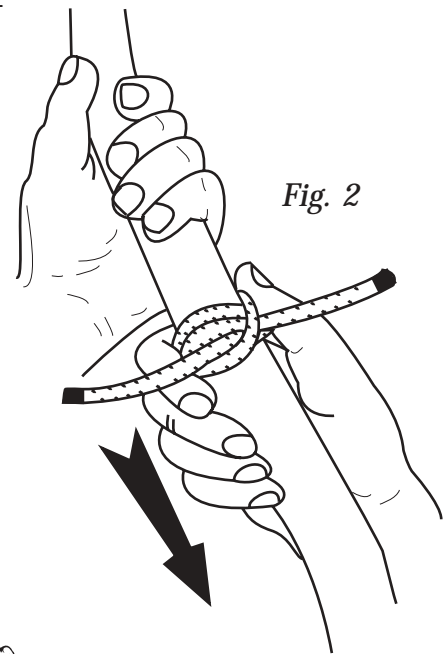

Fig. 2

Final Burying:

The use of shock cord in a rolling hitch around the cover is useful to make final burying easier and more complete. Pull on the hitch toward the eye until all cover slack is removed. (See Fig. 2)



2090 Thornton St.
Ferndale, WA 98248
{T} 360.384.4660 / {F} 360.384.0572

samson
THE STRONGEST NAME IN ROPE

samsonrope.com

Additional Rope Needed for Samson Class 1 Splices

SOFT EYE SPLICE

Circumference of rope in inches expressed as feet, (allows for rope in buried section), plus length of the Eye Splice.

EXAMPLE

Extra rope needed for a 6 ft. soft eye in a 10" circumference 2-in-1 Braid would be 16 ft. (10' + 6').

THIMBLE EYE SPLICE

Circumference of rope in inches expressed as feet, (allows for rope in buried section), plus 1/2 the circumference of the rope in feet, (allows for rope around thimbles).

EXAMPLE

Extra rope needed for a Thimble Eye Splice in 15" circumference 2-in-1 Braid would be 22 ft. (15' plus 7-1/2').

END-FOR-END SPLICE

Circumference of rope in inches expressed as in feet times 2.

EXAMPLE

End-for-End Splice in 8" circumference 2-in-1 Braid figure on 16 ft. extra for the buried sections of the crossover.



2090 Thornton Street
Ferndale, Washington 98248
{T} 360.384.4669 / {F} 360.384.0572

samsonrope.com

©2004 Samson Rope Technologies 4.2.04



FID INFORMATION

FID LENGTH DEFINITION

The "fid length" for a rope is calculated as 21 times the rope diameter. As the rope diameter increases, so does the fid length. For example the fid length for a 4" diameter rope is 84".

The length of the splicing tool, called a "fid", may or may not have a 1:1 correlation with the fid length for a given rope diameter. Refer to the example above and imagine trying to splice a 4" diameter rope with an 84" fid. To keep fids to a manageable length, they may be scaled to the actual fid length of a given rope diameter. Our tubular fids are 100% scale, meaning that the overall length of the tool is equal to the actual fid length for the corresponding rope diameter. Our wire fids are 1/2 scale, meaning that the length of the tool is 1/2 the actual fid length for the corresponding rope diameter.

CALCULATING FID SHORT SECTION

1/4" – 1/2" short section is 37.5% of fid length

9/16" – 3/4" short section is 30% of fid length

7/8" and up short section is 25% of fid length

ALUMINUM TUBULAR FIDS

A different sized splicing fid is required for each size of rope.



Fid Size = Rope Dia. (Inches)	Total Fid Length (Inches)	Short Fid Section (Inches)
1/4"	5-1/2"	2-1/16"
5/16"	6-3/4"	2-1/2"
3/8"	7-3/4"	2-7/8"
7/16"	9-1/2"	3-9/16"
1/2"	11"	4-1/8"
9/16"	12-1/4"	3-5/8"
5/8"	14"	4-1/8"
3/4"	16"	4-3/4"
7/8"	19"	4-3/4"
1"	21"	5-1/4"

WIRE FIDS

For rope sizes above 3" circumference (1" diameter), use a wire fid. Fid scale: 1/2 (for rope diameters between 1" and 2").

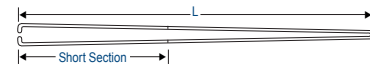

Fid Size = Rope Dia. (Inches)	Total Fid Length "L" (Inches)	Short Section "C" (Inches)
1"	10-1/2"	2-5/8"
1-1/8"	12-1/4"	3"
1-1/4"	13-1/4"	3-1/4"
1-5/16"	14"	3-1/2"
1-1/2"	16"	4"
1-5/8"	17-1/2"	4-1/2"
1-3/4"	19"	4-3/4"
2"	21"	5-1/4"